



**tabbies®**

# Healthcare Filing, Indexing & Labeling Products

**simple solutions @ work®**





## table of contents

### PRACTICE MARKETING/GIVEAWAYS .....4

children's stickers .....	4
medical information cards .....	4
temporary tattoos .....	4

### PATIENT CHART INDEX TABS & DIVIDER SHEETS .....5-9

admission index tabs & divider sheets .....	7
divider sheets .....	7, 9
erasable write-on index tabs .....	7
index tab filebacks & dividers - custom .....	6
patient chart index divider sets .....	7
patient chart index tabs .....	9
tabs-u-create & divider sheets .....	8

### FORMS.....5

HCFA/CMS 1500 claim forms .....	5
patient sign-in label forms .....	5

### FILE FOLDERS .....14

### FILING ACCESSORIES ..... 15-17, 19-21

cd saver™ sleeve protectors .....	21
color code filing made easy .....	23
conversion products .....	16
divider sheets .....	5
expanding divider pockets .....	20
fastener positioning guide .....	17
fasteners .....	17
fileback dividers .....	15
installation solutions - custom .....	22
lock-it pockets .....	20
name label protectors/page edge reinforcers ...	19
outguides .....	21
poly & vinyl pockets .....	20
reinforcing strips .....	21
self-adhesive divider sheets .....	15

### LABELS .....4-22

blank strip labels .....	8
children's stickers .....	4
col'r'tab II refill labels .....	8
communication labels .....	10-12
file folder labels .....	18
labels - custom .....	22
labels-u-create .....	8
laser/inkjet file folder labels .....	18
laser/inkjet label sheets .....	13
medical information cards .....	4
medical transcription labels .....	5
temporary tattoos .....	4
wrap-around file folder labels .....	18

### COLOR CODE LABEL SYSTEMS..... 27-37

color code filing made easy .....	23
<b>Acme Visible® Compatible</b> .....	27, 37
alpha .....	27
numeric .....	27
yearcode .....	37
<b>Ames® Compatible</b> .....	35, 37
numeric .....	35
yearcode .....	37
<b>Barkley® Compatible</b> .....	28, 38
alpha .....	28
numeric .....	28
yearcode .....	38
<b>Original Col'R'Tab®</b> .....	24-26, 35-37
alpha .....	24-26
designator .....	36
double digit .....	26
month .....	26
numeric .....	24-26, 35
yearcode .....	37
<b>Colwell® Compatible</b> .....	29, 38
alpha .....	29
numeric .....	29
yearcode .....	38
<b>GBS/VR® Compatible</b> .....	29, 30, 38
alpha .....	29, 30
numeric .....	29, 30
yearcode .....	38
<b>Jeter® Compatible</b> .....	30, 31, 36, 38
alpha .....	30, 31
designator .....	36
numeric .....	30, 31
yearcode .....	38
<b>Kardex® Compatible</b> .....	27, 28, 36
alpha .....	27
numeric .....	28
designator .....	36
<b>PMA® Compatible</b> .....	39
yearcode .....	39
<b>POS® Compatible</b> .....	31
alpha .....	31
<b>SFI® Compatible</b> .....	35, 37
numeric .....	35
yearcode .....	37
<b>Smead® Compatible</b> .....	32, 33, 39
alpha .....	32, 33
numeric .....	32, 33
yearcode .....	39
<b>Tab Products® Compatible</b> .....	30, 33, 34, 39
alpha .....	30, 33, 34
numeric .....	30, 33, 34
yearcode .....	39
<b>Original Tabbies®</b> .....	34, 36, 37
alpha .....	34
designator .....	36
month .....	34
numeric .....	34
yearcode .....	37

## numerical stock index

11000 - 11009.....	24	42000 .....	24	71221 - 71246.....	34	MAP1570 .....	10
11015 .....	24-27	42030 .....	24	71520 .....	31	MAP1580 .....	9
11050 - 11059.....	25	42100 .....	25	71521 - 71564.....	31	MAP1600 .....	9
11100 - 11113.....	36	49401 - 49406.....	18	71600 - 71609.....	28	MAP1630 .....	9
11190 - 11199.....	26	49430 .....	12, 18	71620 .....	28	MAP164 .....	9
11200 .....	26	49431 - 49443.....	18	71621 - 71647.....	28	MAP1650 .....	10
11500 - 11509.....	25	51719 - 51725.....	37	71719 - 71725.....	37	MAP1720 .....	10
11600 - 11613.....	36	52100 .....	5	71821 - 71846.....	32	MAP1730 .....	9
11719 - 11725.....	37	52102 - 52123.....	5	74500 - 74504.....	21	MAP2010 .....	10
11830 - 11842.....	26	53110 .....	36	74520 .....	21	MAP2020 .....	9
11850 - 11862.....	26	53300 - 53310.....	36	74530 - 74534.....	21	MAP2200 .....	10
11881 - 11892.....	26	53500 - 53510.....	36	74559 .....	21	MAP2350 .....	9
12000 .....	24-26	53520 - 53521.....	5	74580 - 74585.....	21	MAP2500 .....	10
12001 - 12042.....	24	54460 .....	20	81000 - 81009.....	24	MAP2650 .....	10
12101 - 12127.....	25	54470 - 54471.....	20	81500 - 81509.....	25	MAP2670 .....	10
12500 - 12509.....	27	54492 - 54499.....	20	81719 - 81725.....	37	MAP2830 .....	10
12619 - 12625.....	37	54500 .....	7	81951 - 81976.....	26	MAP286 .....	10
12701 - 12714.....	27	54505 .....	7	82001 - 82042.....	24	MAP2880 .....	10
12800 - 12809.....	35	54519 - 54520.....	5	82051 - 82077.....	25	MAP2890 .....	10
12919 - 12925.....	37	54522 - 54596.....	5	82101 - 82127.....	25	MAP2900 .....	10
138-0 - 138-9.....	28	54651 - 54652.....	4	84101 - 84127.....	33	MAP2940 .....	10
139-A - 139-Z.....	27	55990 - 55996.....	16	88385 .....	19	MAP3080 .....	10
140-0 - 140-9.....	28	56012 - 5601213.....	14	88485 .....	19	MAP3090 .....	10
14000 - 14009.....	33	56015 - 5601513.....	14	90100 - 90109.....	34	MAP3230 .....	9
14101 - 14127.....	33	56018 - 5601813.....	14	90110 .....	28-34	MAP3240 .....	9
14419 - 14425.....	38	56019 - 5601913.....	14	90121 - 90146.....	34	MAP3250 .....	9
144-A - 144-Z.....	27	56022 - 56024.....	14	90150 .....	28-34	MAP327 .....	9
14500 .....	7	56025 - 5602513.....	14	90419 - 90425.....	38	MAP3290 .....	9
14501 - 14512.....	7	56055 - 5605513.....	14	90519 - 90525.....	38	MAP3300 .....	9
14530 - 14532.....	5	56058 - 5605813.....	14	90619 - 90625.....	38	MAP3360 .....	9
14540 .....	5	56222 - 5622213.....	14	90819 - 90825.....	39	MAP3400 .....	9
14560 - 14569.....	35	56600 - 566001.....	14	90919 - 90925.....	38	MAP3410 .....	9
14600 - 14609.....	30	56760 - 567601.....	14	91000 - 91009.....	33	MAP345 .....	9
14611 - 14637.....	30	56804 .....	17	91010 .....	33	MAP3500 .....	9
14919 - 14925.....	37	56805 .....	17	91021 - 91047.....	33	MAP3530 .....	10
20001 - 20010.....	4	56807 .....	17	91100 - 91109.....	30	MAP3550 .....	10
20100 .....	4	56809 .....	17	91121 - 91147.....	30	MAP3600 .....	10
21819 - 21825.....	39	56811 - 56812.....	17	91219 - 91225.....	39	MAP3720 .....	10
24530 - 24532.....	5	56820 .....	17	91300 - 91309.....	29	MAP4170 .....	10
24541 .....	5	58385 - 58385B.....	19	91310 .....	29	MAP4180 .....	10
25100 - 25101.....	21	58390 .....	21	91320 .....	29	MAP4220 .....	9
26330 - 2633013.....	15	58392 .....	21	91321 - 91347.....	29	MAP4250 .....	9
26360 .....	15	58485 .....	19	91400 - 91409.....	29	MAP4480 .....	9
26370 .....	15	58530 .....	7	91410 .....	29	MAP4490 .....	9
26372 .....	15	58600 - 58610.....	7	91420 .....	29	MAP4630 .....	9
28401 .....	4	58700 - 58710.....	7	91421 - 91447.....	29	MAP4770 .....	9
28451 .....	4	58727 .....	7	91500 - 91509.....	31	MAP4800 .....	9
28471 .....	4	58800 - 58810.....	7	91520 .....	31	MAP4830 .....	9
28501 - 28502.....	4	58900 - 58910.....	7	91521 - 91564.....	31	MAP4840 .....	9
30010 - 30011.....	8	59430 - 59443.....	18	91600 - 91609.....	28	MAP486 .....	9
31000 .....	24	59513 .....	5	91621 - 91647.....	28	MAP488 .....	9
31100 .....	30	59530 - 59534.....	5	91800 - 91809.....	32	MAP4890 .....	9
31120 .....	30	61021 - 61047.....	33	91821 - 91846.....	32	MAP4910 .....	9
31600 .....	28	61321 - 61347.....	29	91921 - 91933.....	32	MAP4930 .....	9
31620 .....	28	61421 - 61447.....	29	91981 - 91993.....	36	MAP5140 .....	9
31920 .....	32	61521 - 61564.....	31	92019 - 92025.....	39	MAP5150 .....	9
31950 .....	26	62231 - 62240.....	31	94619 - 94625.....	38	MAP5180 .....	9
32000 .....	24	62241 - 62267.....	31	94900 - 94909.....	35	MAP5240 .....	10
32030 .....	24	68386 .....	19	97119 - 97625.....	39	MAP5260 .....	10
32100 .....	25	68387 .....	19	MAP1000 .....	9	MAP539 .....	10
34651 - 34652.....	4	70219 - 70225.....	37	MAP1030 .....	10	MAP5310 .....	10
40100 - 40103.....	8	70231 - 70242.....	34	MAP1040 .....	10	MAP5500 .....	10
40120 - 40123.....	8	70519 - 70525.....	37	MAP1050 .....	9	MAP6260 .....	10
40140 - 40143.....	8	70521 - 70533.....	36	MAP1110 .....	10	MAP6420 .....	10
40150 - 40165.....	12	70819 - 70825.....	39	MAP113 .....	10	MAP6470 .....	9
40200 - 40202.....	8	71000 - 71009.....	33	MAP120 .....	10	MAP7190 .....	10
40506 - 40554.....	11	71010 .....	33	MAP1310 .....	10	SS16 .....	9
40560 - 40562.....	9	71020 .....	33	MAP1320 .....	9	TP240-A - TP240-MC .....	33
40566 .....	9	71021 - 71047.....	33	MAP1340 .....	10	UL007 .....	10
40570 .....	10	71100 - 71109.....	30	MAP1350 .....	9	UL520 .....	10
41000 .....	24	71110 .....	30	MAP1510 .....	9	UL808 .....	9
41020 .....	33	71120 .....	30	MAP1030 .....	10	UL926 .....	9
41800 .....	32	71121 - 71147.....	30	MAP1550 .....	9	UL927 .....	9
41820 .....	32	71200 - 71209.....	34	MAP1560 .....	10		

## practice marketing/giveaways

### stickers & temporary tattoos

stickers and temporary tattoos are a fun way to promote learning, motivate and reward children. Great as patient giveaways.



stock no.	description	qty. per pkg.	qty. per box
28401	VeggieTales® Character Stickers	24/pkg.	10 pkgs./box
28451	VeggieTales® Temporary Tattoos	16/pkg.	10 pkgs./box
28471	VeggieTales® Scratch'n'Smell Stickers	54/pkg.	10 pkgs./box
28501	Aetherlight Character Stickers	24/pkg.	10 pkgs./box
28502	Aetherlight Action Stickers	24/pkg.	10 pkgs./box

### medical information cards

ICE Medical Alert Card and MED Card are the size of a credit card and are perfect as giveaways for; Doctors' Offices, Hospitals, Retirement Homes/Extended Care Facilities, College Admissions Packets, New Hire Packets, And Much More. These useful cards allow the individual to fill in pertinent medical information that can then be stored in a wallet in case of emergency or for quick reference. ICE Medical Alert Card and MED Card have a laminating seal to protect the written information and eliminate smudging. Folded together, the card is strong, durable and water resistant. Empty displays available.



**The cards are also customizable to fit your business needs. Contact Customer Service for a Quote.**

stock no.	description	size	qty. per pkg.	qty. per box
54651	ICE Medical Alert Card	3-3/8" w x 2-1/8" h	25/pkg.	4 pkgs./box
54652	MED Card	3-3/8" w x 2-1/8" h	25/pkg.	4 pkgs./box
34651	ICE Medical Alert Card Counter Display	3-1/8" d x 2-3/4" w x 9-1/8" h	-	150/display
34652	MED Card Counter Display	3-1/8" d x 2-3/4" w x 9-1/8" h	-	150/display

### children's stickers

These children's stickers are a fun way to make your young patients feel special after each visit.

**Roll Kit 20100** Please specify your five rolls at the time of order.



stock no.	description	size	qty. per roll	qty. per unit
20001	#1 Patient Dino	1-3/4"	100/roll	
20002	I Grew This Much	1-3/4"	100/roll	
20003	I'm Healthy Cat	1-3/4"	100/roll	
20004	Star Patient	1-3/4"	100/roll	
20005	I'm a Princess	1-3/4"	100/roll	
20006	Superstar Patient	1-3/4"	100/roll	
20007	#1 Patient Car	1-3/4"	100/roll	
20008	Toad-Ally Great	1-3/4"	100/roll	
20009	Great Checkup	1-3/4"	100/roll	
20010	I'm Cavity Free	1-3/4"	100/roll	
20100	Unit - choose 5 rolls	13-1/2" w x 4" h		5 rolls



## patient sign-in label forms

Confidentially sign in your patients with **patient sign-in label forms**. Forms limit access to personal information as required by HIPAA compliance regulations. Patients sign in on next available removable numbered label strip. Patient then takes the numbered label and waits to be called by name or number. Office staff removes numbered label strip with patient name and adheres it to patient chart to help improve recordkeeping. Once label strips have been removed, the patient information is now protected behind special backing paper. The Sign-In form also provides a confidential daily patient log.



stock no.	description	color	size	qty. per pkg
14530	Patient Sign-In Label Form	Salmon	8-1/2" x 11"	125
14531	Patient Sign-In Label Form	Blue	8-1/2" x 11"	125
14532	Patient Sign-In Label Form	Green	8-1/2" x 11"	125
14541	Bilingual Patient Sign-In Label Form-Spanish	Blue	8-1/2" x 11"	125
24530	Patient Sign-In Label Form	Salmon	8-1/2" x 11"	250
24531	Patient Sign-In Label Form	Blue	8-1/2" x 11"	250
24532	Patient Sign-In Label Form	Green	8-1/2" x 11"	250
24541	Bilingual Patient Sign-In Label Form-Spanish	Blue	8-1/2" x 11"	250

## HCFA/CMS 1500 claim forms

Speed up third-party billing and manage your cash flow with these HCFA/CMS 1500 claim forms (Health Care Financing Administration/Center for Medicare and Medicaid Services) using your laser printer. Printed with OCR 'dropout' red ink on 20 lb. paper per government regulations. Accommodates NPI numbers as mandated by HIPAA compliance regulations. Includes all updates to the 02/12 version approved by the NUCC (National Uniform Claim Committee).

stock no.	description	size	qty. per pkg
14540	HCFA/CMS 1500 Claim Forms	8-1/2" x 11"	500



## medical transcription labels

### laser printer transcription labels

Trouble-free **laser sheets** pass through your laser printer without jamming. Perforated backs and 1/4" margins allow for easy detaching. White.

stock no.	label size	full sheet size	qty. per box	qty. per carton
59530	1" strips, perf-thru	8-1/2" x 11"	100	
59531	2" strips, perf-thru	8-1/2" x 11"	100	
59533	11" full sheet	8-1/2" x 11"	100	
59534	11" full sheet	8-1/2" x 11"		1000

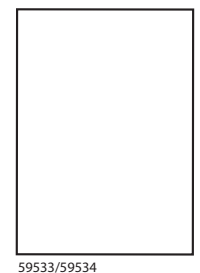
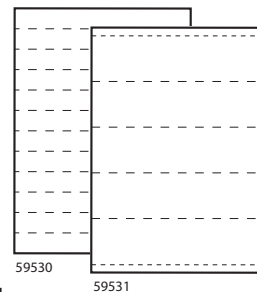

### pin feed transcription labels

High quality **pin feed labels** are formatted on continuous fan-folded sheets. White.

stock no.	label size	full sheet size	qty. per box
59513	7-5/8" fan-folded	8-5/8" x 12"	208

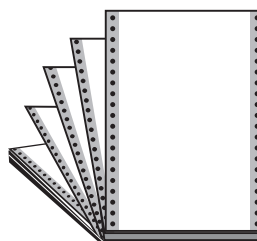

## custom index tab filebacks & dividers

### Custom Index Tab Dividers

**custom index tab dividers** are the cost-effective choice for organizing important papers within your file folder or binder. From medical charts to legal folders or overall general filing, using **custom index tab dividers** allows for quick access to information in a wide range of applications. Choose your own tab titles, color selection, and style that will fit your budget and filing needs.

#### CUSTOM INDEX

Easy Ordering Instructions:

- Specify paper weight and divider color:
  - 90 lb. or 110 lb.
  - White or ivory (manila) stock
- Choose tab print style and punch hole positions:
  - Side or bottom tabs
  - 5, 3, or 2 hole punch
- Specify tab cut size and tab extension
- List tab titles, positions, and colors
- Choose packaging options:
  - Collated / titles boxed together in sets
  - Non-Collated / each title boxed individually

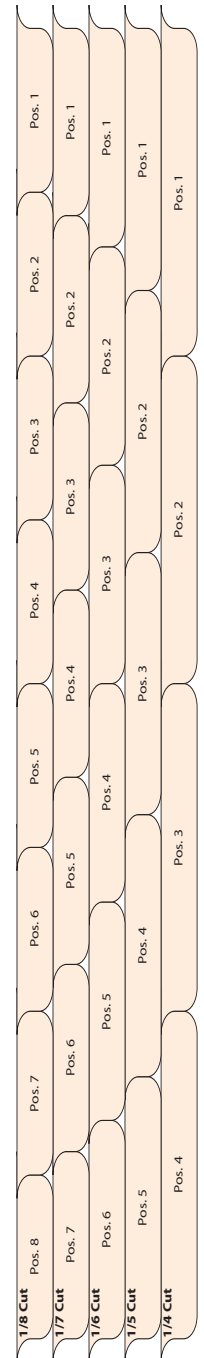
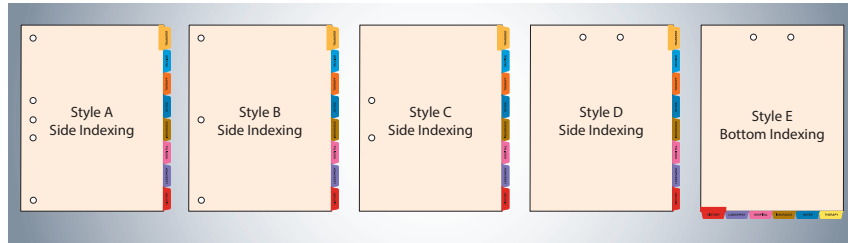

### Custom Fileback Dividers

**custom fileback dividers** take file organization one step further. Each section is self-contained and information can be easily removed without disturbing other sections. Each **custom fileback divider** has a permanent heat-bonded fastener applied to the top or side of the divider allowing for easy and quick retrieval of information.

#### CUSTOM FILEBACK

Easy Ordering Instructions:

- Specify side or bottom tabs
- Choose fastener: top or side
- Specify style:
  - hinge or self-adhesive
- List tab positions, titles, and colors
- Choose packaging options:
  - Collated / titles boxed together in sets
  - Non-Collated / each title boxed individually

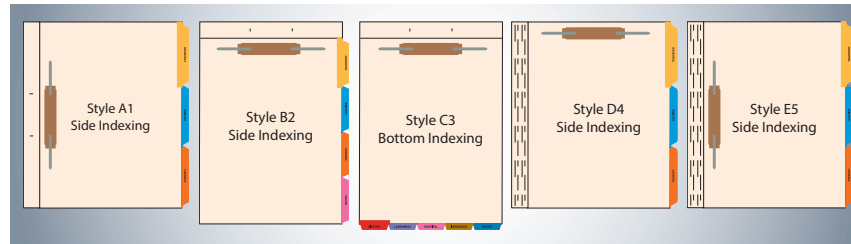

**TAB TIP:** Plan ahead! Allow for expansion and add a write-on erasable tab to use for your specific office needs.

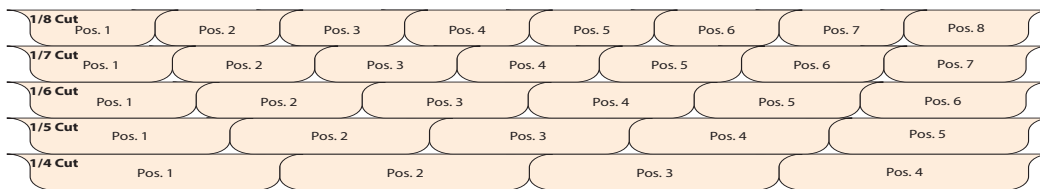
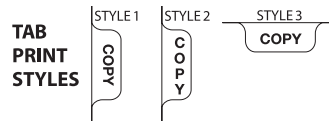

#### AVAILABLE COLORS:

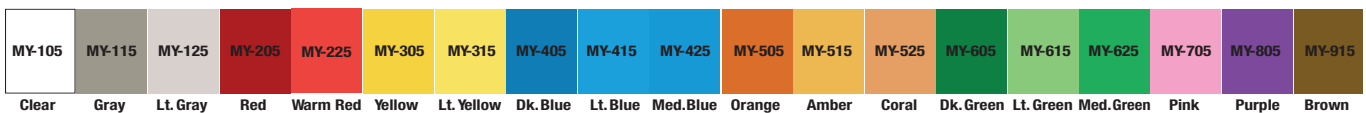

### Custom Divider Applications Include:

- ◆ Banking and Financial Records
- ◆ Medical Records
- ◆ Insurance Offices
- ◆ Hospital Patient Charts
- ◆ Spiral Bound Books
- ◆ Employee Handbooks
- ◆ Mortgage Loan Files
- ◆ Product Catalogs
- ◆ Manuals
- ◆ Price Books/Lists
- ◆ Telephone Directories
- ◆ Instruction Manuals
- ◆ Legal Briefs
- ◆ Sales Presentations

**Save Time & Money**  
by letting us install  
dividers in your file folders



## patient chart index divider sets

Use **tabbies patient chart index divider sets** to organize patient charts, files, or records. Sets come collated. Minimum Purchase: 40 sets (1 box). **No tab substitutions. Contact us for custom sets.**

Sets consist of the following tabs:

Tab Position	Title	Tab Color
1	HISTORY & PHYSICAL	Blue
2	PROGRESS NOTES	Yellow
3	CORRESPONDENCE	Orange
4	LAB/X-RAY	Green
5	HOSPITAL	Red
6	INSURANCE	Brown
7	MISCELLANEOUS	Pink
8	BLANK WRITE-ON	White

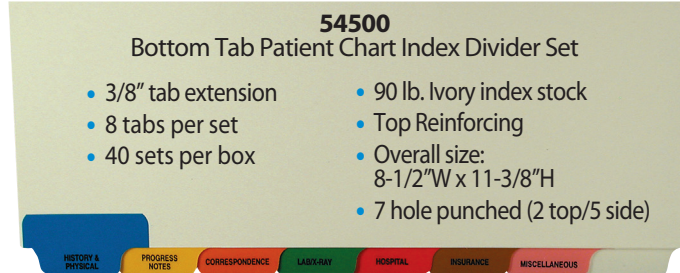

stock no.	description	tab ext.	Overall size	UOM
54500	Bottom Tab Patient Chart Index Divider Set	3/8"	8-1/2" x 11-3/8"	40 Sets/Bx
54505	Side Tab Patient Chart Index Divider Set	1/2"	9" x 11"	40 Sets/Bx

**54505**  
Side Tab Patient Chart Index Divider Set

- 1/2" tab extension
- 8 tabs per set
- 40 sets per box
- 90 lb. Ivory index stock
- Side Reinforcing
- Overall size: 9"W x 11"H
- 7 hole punched (2 top/5 side)

## admission index tabs & divider sheets

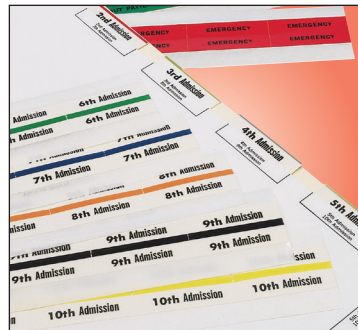

**admission index tabs** and **divider sheets** make indexing of admission files easy and economical. No more wasted pre-tabbed and numbered divider sheets. Tabs are easily attached to position marks on the 8-1/2" x 11" four-hole punched divider sheets. Admission index tabs and divider sheets can be used for either side or top fastened medical record folders. Self-adhesive 1-1/2" tabs are plastic laminated. 100 per package.

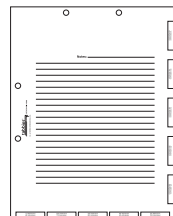

stock no.	title	color edge
14501	1st Admission	Light Blue
14502	2nd Admission	Red
14503	3rd Admission	Light Green
14504	4th Admission	Gray
14505	5th Admission	Gold
14506	6th Admission	Green

stock no.	title	color edge
14507	7th Admission	Blue
14508	8th Admission	Orange
14509	9th Admission	Black
14510	10th Admission	Yellow
14512	OUTPATIENT	Green (solid)

tabbies has a variety of **index divider sheets** in stock or we can customize to accommodate any tab size for your filing needs.

stock no.	description (400 sheets per box)
14500	4-hole punched Admission Index Divider Sheets

## erasable write-on index tabs



**erasable write-on index tabs** can be used over and over again. Write with pencil or any erasable ink pen – then just erase and reuse. Tabs have 1/2" tab extension with colored edges or solid color fluorescent tabs. Ideal for any filing, flagging or indexing situation.



color edge	1" 24 tabs/pkg.	1-1/2" 16 tabs/pkg.	2" 12 tabs/pkg.	3" 8 tabs/pkg.	pkgs./box
Yellow	58600	58700	58800	58900	10
Red	58602	58702	58802	58902	10
Green	58606	58706	58806	58906	10
Blue	58607	58707/58727	58807	58907	10
Black	58609	58709	58809	58909	10
White	58610	58710	58810	58910	10

Assorted Solid Colors	stock no.	color	size	tabs/pkg.	pkgs./box
	58530	Fluorescent	1-1/2"	24	10

## tabs-u-create & divider sheets



Use your laser printer and Microsoft Word® with **tabs-u-create** to make custom title indexes in seconds. Self-adhesive tabs are 1-1/4" in length and grip both sides of the page for added strength. Easy set-up instructions come inside each package of index tabs. Use **tabs-u-create divider sheets** to make full index dividers. Tabs have 1/2" tab extension in white or assorted colors. For bottom or side indexing.

stock no.	color	tab size	tabs/sheet	tabs/pkg.
40201	White	1-1/4"	12	60
40202	Assorted	1-1/4"	12	60

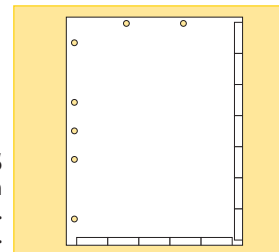

### tabs-u-create divider sheets

**tabs-u-create divider sheets** have position marks for easy placement of index tabs. For bottom or side indexing.

stock no.	sheet size	sheets/pkg.
40200	8-1/2" w x 11" h	50

**Create Indexes in Seconds!**

## labels-u-create



Create bright, eye-catching communication labels in seconds, using your PC and laser printer with **labels-u-create** to make custom labels for any application. Permanent labels can be applied to folders, documents, drawers, even shelving. Make an entire sheet of the same label or just a few at a time. Easy set-up instructions inside. Works with Microsoft Word® No additional software is needed. 10 (8-1/2" x 11") sheets per package. Available in 3 colors plus white.

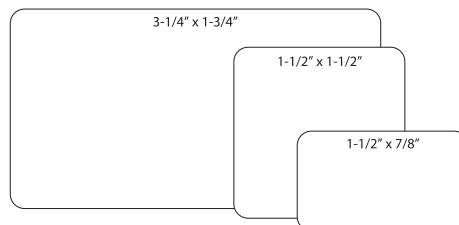

stock no.	label size	color	labels/sheet	labels/pkg.
40100	1-1/2" X 7/8"	White	32	320
40101	1-1/2" X 7/8"	Fl. Red	32	320
40102	1-1/2" X 7/8"	Fl. Green	32	320
40103	1-1/2" X 7/8"	Fl. Yellow	32	320
40120	1-1/2" X 1-1/2"	White	20	200
40121	1-1/2" X 1-1/2"	Fl. Red	20	200

stock no.	label size	color	labels/sheet	labels/pkg.
40122	1-1/2" X 1-1/2"	Fl. Green	20	200
40123	1-1/2" X 1-1/2"	Fl. Yellow	20	200
40140	3-1/4" X 1-3/4"	White	10	100
40141	3-1/4" X 1-3/4"	Fl. Red	10	100
40142	3-1/4" X 1-3/4"	Fl. Green	10	100
40143	3-1/4" X 1-3/4"	Fl. Yellow	10	100



## label refill packages

### Color code filing labels on demand

#### 30010 End Tab File Folder Name Labels

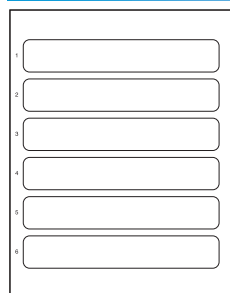

Up to six 1/2" alpha or numeric characters, with two line name label option, year code and 1/2" solid color designator options (6 labels per sheet, 50 sheets per pack) (for use with COL'R'TAB® II label software)

stock no.	description	label size	labels/pkg.
30010	end tab file folder name labels	1-1/4" W X 7-1/2" H	300
30011	top tab file folder name labels	3-1/2" W X 1" H	700

#### 30011 Top Tab File Folder Name Labels

Standard 1/3 cut top tab name label with color stripe option (14 labels per sheet, 50 sheets per pack) (for use with COL'R'TAB® II label software)

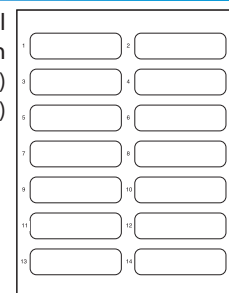
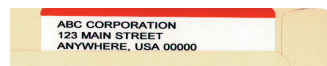

## blank strip labels

Let **TABBIES** quote you on manufacturing any 8-1/2" x 11" strip label sheets. We can match any computer generated blank label configuration for use with any color coded label on demand system in the marketplace today. Call **TABBIES** Customer Service for further information and a quote.



## patient chart index tabs



Create your own titles and colors. Contact us for more details.

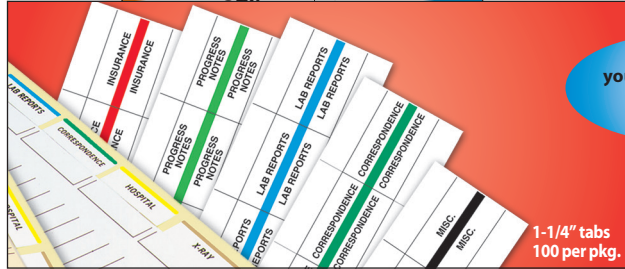
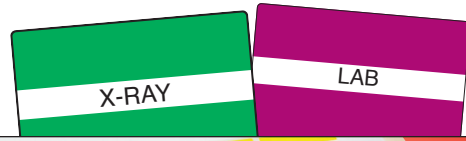

1-1/4" tabs  
100 per pkg.

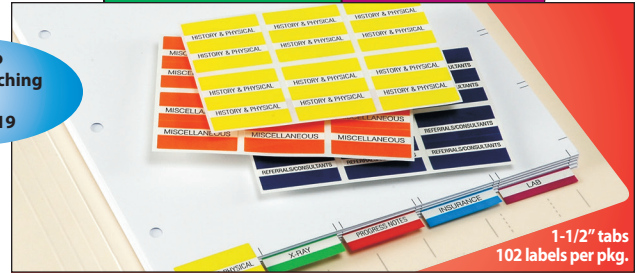

1-1/2" tabs  
102 labels per pkg.

Let us do your tab attaching for you. See Page 19

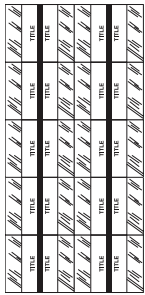

stock no.	title	color
54523	CONSULTS	Green
54524	CORRESPONDENCE	Green
54525	EKG	Red
54546	HIPAA	Red
54528	HISTORY & PHYSICAL	Orange
54544	HOSPITAL	Yellow
54529	INSURANCE	Red
54530	LAB REPORTS	Lt. Blue
54531	LAB/X-RAY	Lt. Blue
54532	MEDICATIONS	Lt. Green
54533	MISC.	Black
54534	NURSES NOTES	Gray
54535	OPERATIVE REPORT	Yellow
54537	PATHOLOGY RESULTS	Green
54538	PHYSICIANS ORDERS	Gold
54539	PROGRESS NOTES	Lt. Green
54542	X-RAY	Tan
54543	X-RAY-EKG	Tan

stock no.	title	color edge
52102	BILLING	Black
52103	CORRESPONDENCE	Brown
52104	DOCTOR'S ORDERS	Gray
52107	HISTORY & PHYSICAL	Lt. Yellow
52109	INSURANCE	Lt. Blue
52110	LAB	Purple
52114	MEDICATION	White
52115	MISCELLANEOUS	Orange
52116	PAP SMEAR	Salmon
52117	PATIENT DATA	Lavender
52119	PROGRESS NOTES	Red
52121	SURGERY	Turquoise
52123	X-RAY	Lt. Green

54522	ALLERGY	Red
54552	CONSENT FORMS	Lt. Green
54553	DIAGNOSTIC	Yellow
54547	HEALTH HISTORY	Dk. Blue
54558	IMMUNIZATION	Dk. Blue
54569	PATIENT INFORMATION	Orange
54571	PHYSICAL THERAPY	Orange
54573	PRESCRIPTION	Red
54540	REFERRALS	Dk. Blue
54577	SURGICAL	Yellow
54580	TREATMENT PLAN	Tan
54589	WRITABLE	White
54596	WRITABLE	Orange



## divider sheets

**divider sheets** are 8-1/2" x 11", 110 lb. white index stock printed with guidelines for fast and accurate placement of the **52100 series** chart divider index tabs. 7-hole punched to be used with fasteners or 3-ring binders.

stock no.	description	qty.
52100	110 lb. white	100/pkg.

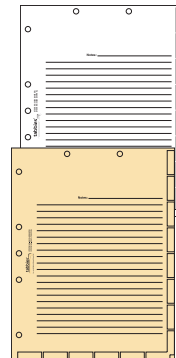
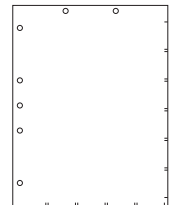

**divider sheets** are 8-1/2" x 11", 110 lb. index stock printed with guidelines for fast and accurate placement of the **54520 series** chart divider index tabs. Sheets are conveniently ruled for making notes and are 7-hole punched to be used with fasteners in folders or 3-ring binders.

stock no.	description	qty.
53520	110 lb. white	100/pkg.
54520	110 lb. white	400/box
53521	110 lb. manilla	100/pkg.
54519	110 lb. manilla	400/box

## communication labels

### allergy labels

stock no.	description	color	size	labels/roll
40560	Allergies	Fl. Red	2" x 2"	500/Roll
40561	Allergic Label	White/Red	5-1/2" x 1"	175/Roll
40562	Allergic To: Wrap-Around	White/Red	3" x 1"	500/Roll
MAP327	Allergies/Drug Reactions	Fl. Red	4" x 2-1/2"	100/Roll
MAP486	Allergies	Fl. Red	4" x 2-1/2"	100/Roll
MAP488	Allergic Penicillin Codeine Sulfa	Fl. Red	4" x 2-1/2"	100/Roll
MAP1000	Allergic To:	White/Red	1-1/2" x 7/8"	250/Roll
MAP1510	No Known Allergies	Lt Blue	1-1/2" x 7/8"	250/Roll
MAP1550	Allergic Penicillin/Codeine/Sulfa	Fl. Chartreuse	3-1/4" x 1-3/4"	250/Roll
MAP1630	Allergies	Fl. Red	3-1/4" x 1-3/4"	250/Roll
MAP1730	Allergies/Drug Reactions	Fl. Pink	3-1/4" x 1-3/4"	250/Roll
MAP3230	Allergies/Drug Reactions	Fl. Red	3-1/4" x 1-3/4"	250/Roll
MAP3240	Allergic To:	Fl. Red	3" x 1"	250/Roll
MAP3250	Allergies Listing	Fl. Red	3-1/4" x 1-3/4"	250/Roll
MAP3290	Allergic To	White/Red	3" x 1"	250/Roll
MAP3300	Allergy - Allergic To	White/Red	3-1/4" x 1-3/4"	250/Roll
MAP3360	Allergic	White/Red	3" x 1"	250/Roll
MAP4890	Allergic To Penicillin Codeine Sulfa	Fl. Red	2" x 2"	250/Roll
MAP4910	Allergic To	Fl. Chartreuse	1-1/2" x 7/8"	250/Roll
MAP4930	Allergy Alert	Fl. Red	1-1/2" x 7/8"	250/Roll
MAP5140	Medication Allergy	White/Red	3-1/4" x 1-3/4"	250/Roll
SS16	Allergic To	Fl. Red	1-7/8" x 3/4"	500/Roll
UL808	Allergic To	Fl. Red	2-1/4" x 7/8"	420/Roll
UL926	Allergies	Fl. Red	2-1/2" x 2-1/2"	390/Roll
UL927	Allergic	White/Red	5-1/2" x 1"	240/Roll



MAP327



MAP486

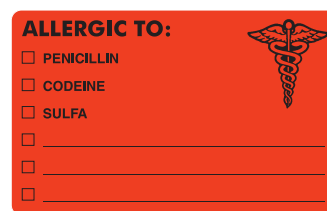

MAP488

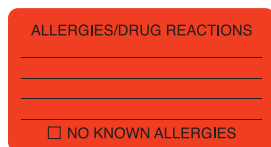

MAP3230



40560



40561/UL927

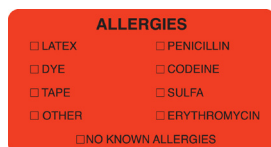

MAP3250

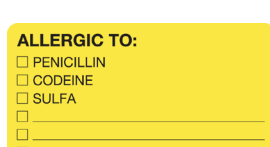

MAP1550



40562



MAP3240



MAP3290

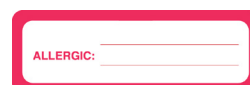

MAP3360



MAP3300



MAP1630



MAP1000



MAP1510



MAP4910



MAP4930



MAP5140

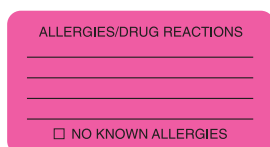

MAP1730

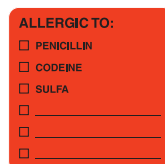

MAP4890



SS16



UL808



UL926



## communication labels

### attention/alert labels

stock no.	description	color	size	labels/roll
MAP164	Medical Alert	Fl. Red	1-1/4"x15/16"	500/Roll
MAP345	Name Alert	Fl. Chartreuse	1-1/4"x5/16"	500/Roll
MAP1050	Name Alert Same Name	Fl. Chartreuse	1-1/2" x 7/8"	250/Roll
MAP1600	Medical Alert:	White/Red	1-1/2" x 7/8"	250/Roll
MAP3400	Name Alert	Fl. Chartreuse	3-1/4" x 1-3/4"	250/Roll
MAP3410	Name Alert D.O.B.	Fl. Chartreuse	3-1/4" x 1-3/4"	250/Roll
MAP3500	Advanced Directive	Fl. Orange	3-1/4"x1-3/4"	250/Roll
MAP5150	Name Alert	Blue	3-1/4"x1-3/4"	250/Roll
MAP5180	Medical Alert	Fl. Red	3-1/4"x1-3/4"	250/Roll
MAP6470	Name Alert Same Name	Fl. Chartreuse	3"x1"	250/Roll

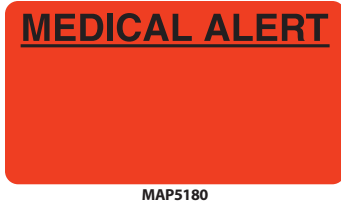

MAP5180

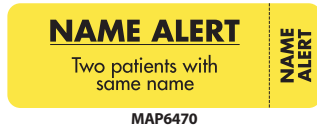

MAP6470

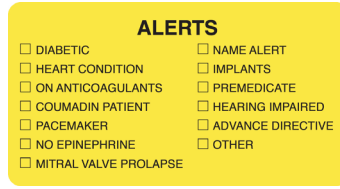

MAP3400

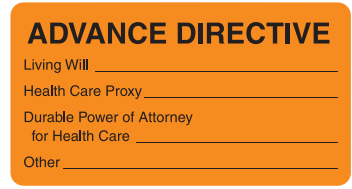

MAP3500

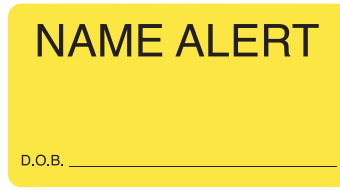

MAP3410



MAP5150

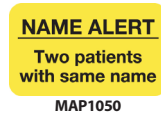

MAP1050

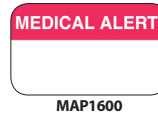

MAP1600



MAP164



MAP345

### billing/collection labels

stock no.	description	color	size	labels/roll
40566	Attention Co-Pay Label	Fl. Red	3" x 1"	500/Roll
MAP1320	Self Pay	Fl. Green	1-1/2" x 7/8"	250/Roll
MAP1350	Past Due Remit Today	Fl. Red	1-1/2" x 7/8"	250/Roll
MAP1580	Final Notice	Fl. Red	3-1/4" x 1-3/4"	250/Roll
MAP2020	Partial Payment Needed	Fl. Pink	1-1/2" x 7/8"	250/Roll
MAP2350	Transfer Balance Credit Card	Fl. Orange	3-1/4" x 1-3/4"	250/Roll
MAP4220	Reminder Account Overdue	Fl. Green	1-1/2" x 7/8"	250/Roll
MAP4250	Friendly Reminder	Fl. Orange	1-1/2" x 7/8"	250/Roll
MAP4480	Account Past Due	Fl. Red	1-1/2" x 7/8"	250/Roll
MAP4490	Balance Overdue	Fl. Red	1-1/2" x 7/8"	250/Roll
MAP4630	Balance Transfer	Fl. Chartreuse	1-1/2" x 7/8"	250/Roll
MAP4770	Final Notice	Fl. Red	1-1/2" x 7/8"	250/Roll
MAP4800	Contact for Payment	Fl. Chartreuse	3-1/4" x 1-3/4"	250/Roll
MAP4830	Final Notice cc	Fl. Red	3-1/4" x 1-3/4"	250/Roll
MAP4840	90 Days Past Due	Fl. Red	3-1/4" x 1-3/4"	250/Roll



MAP4250



MAP4480



MAP4490



MAP4630



4770

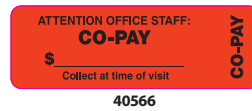

40566

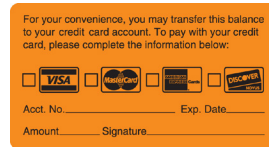

MAP2350

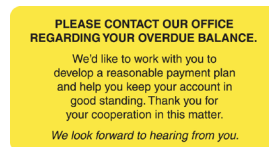

MAP4800

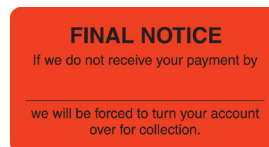

MAP1580



MAP1320



MAP1350



MAP2020



MAP4220

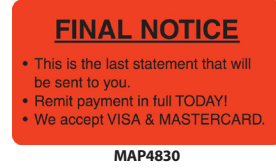

MAP4830



MAP4840

### chart labels

stock no.	description	color	size	labels/roll
MAP1720	Rh Negative	Red	1-1/2" x 7/8"	250/Roll
MAP2010	DNR	Fl. Orange	1-1/2" x 7/8"	250/Roll
MAP3530	Diabetic	Fl. Pink	1-1/2" x 7/8"	250/Roll
MAP3550	Minor	Fl. Green	1-1/2" x 7/8"	250/Roll
MAP3600	Medical History	Fl. Chartreuse	3-1/4" x 1-3/4"	250/Roll



MAP1720



MAP2010



MAP3530



MAP3550

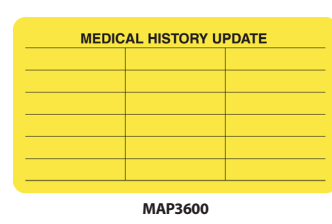

MAP3600

### hipaa labels

stock no.	description	color	size	labels/roll
40570	Confidential Authorized Personnel Label	Red	2" x 2"	500/Roll
MAP7190	HIPAA	Fl. Red	1-1/2" x 7/8"	250/Roll



40570



MAP7190

## communication labels

### insurance labels

stock no.	description	color	size	labels/roll
MAP113	Medicare	Fl. Orange	1-1/4" x 5/16"	500/Roll
MAP120	Medicaid	Fl. Pink	1-1/4" x 5/16"	500/Roll
MAP286	No Insurance	Fl. Green	1-1/4" x 5/16"	500/Roll
MAP539	Medi-Cal	Fl. Red	1-1/4" x 5/16"	500/Roll
MAP1030	HMO	Fl. Red	1-1/2" x 7/8"	250/Roll
MAP1040	HMO/PPO	Fl. Red	1-1/2" x 7/8"	250/Roll
MAP1110	Insurance Provider	White/Red	1-1/2" x 7/8"	250/Roll
MAP1310	Attention Staff Co-Pay	Fl. Red	1-1/2" x 7/8"	250/Roll
MAP1340	Medicaid	Fl. Pink	1-1/2" x 7/8"	250/Roll
MAP1570	Insurance	Fl. Red	3-1/4" x 1-3/4"	250/Roll
MAP1650	BC/BS	Lt. Blue	1-1/2" x 7/8"	250/Roll
MAP2500	We Accept Credit Cards	Fl. Chartreuse	3-1/4" x 1-3/4"	250/Roll
MAP2650	Documentation Attached	Fl. Green	1-1/2" x 7/8"	250/Roll
MAP2670	Resubmission Not a Duplicate	Fl. Green	1-1/2" x 7/8"	250/Roll
MAP2830	Insurance	Fl. Pink	3-1/4" x 1-3/4"	250/Roll
MAP2880	Insurance	Fl. Red	1-1/2" x 7/8"	250/Roll
MAP2890	Co Pay	Fl. Orange	1-1/2" x 7/8"	250/Roll
MAP2900	Blue Cross	Lt. Blue	1-1/2" x 7/8"	250/Roll
MAP2940	Insurance Listing	Fl. Chartreuse	3-1/4" x 1-3/4"	250/Roll
MAP3080	Medicare	Fl. Orange	3" x 1"	250/Roll
MAP3090	Medicaid	Fl. Pink	3" x 1"	250/Roll
MAP5240	Medicaid	Fl. Pink	1-1/2" x 7/8"	250/Roll
MAP5260	Medicare/HMO	Lt. Blue	1-1/2" x 7/8"	250/Roll
MAP5310	Worker's Comp	Fl. Green	1-1/2" x 7/8"	250/Roll
MAP5500	Prior Approval	Fl. Chartreuse	1-1/2" x 7/8"	250/Roll
MAP6260	Allergic to Latex	Red	1-1/2" x 7/8"	250/Roll
MAP6420	Insurance	Fl. Pink	3" x 1"	250/Roll
UL007	Insurance	Fl. Chartreuse	1-5/8" x 7/8"	500/Roll

**MEDICARE** MAP113 **HMO**  
**MEDICAID** MAP120 **HMO/PPO**  
**NO INSURANCE** MAP286 **INSURANCE PROVIDER**  
**MEDI-CAL** MAP539 **ATTENTION OFFICE STAFF CO-PAY**  
**MEDICAID** MAP1030 **MEDICAID** MAP1040 **BC/BS**  
**NO INSURANCE** MAP1110 **DOCUMENTATION ATTACHED DO NOT SEPARATE FROM CLAIM**  
**MEDI-CAL** MAP1310 **RESUBMISSION: This is not a duplicate billing. This claim has either been denied or never received. Please consider for benefits.**  
**INSURANCE** MAP1340 **CO-PAY** MAP1650 **MAP2650** **MAP2670**  
**INSURANCE** MAP2880 **MEDICARE HMO** MAP2890 **WORKER'S COMP** MAP2900 **PRIOR APPROVAL REQUIRED** MAP5240 **ALLERGIC TO LATEX**  
**INSURANCE** MAP5260 **MAP5310** MAP5500 **MAP6260**  
**INSURANCE** UL007 **MEDICARE** MAP3080 **INSURANCE**  
**MEDICAID** MAP3090 **MEDICAID** MAP6420 **INSURANCE**  
**INSURANCE** MAP1570 **INSURANCE** MAP2500 **INSURANCE**  
**INSURANCE** MAP2830 **INSURANCE** MAP2940 **INSURANCE**

### patient responsibility labels

stock no.	description	color	size	labels/roll
MAP1560	Claim Not Paid Insurance	Fl. Chartreuse	3-1/4" x 1-3/4"	250/Roll
MAP2200	Insurance Paid You Owe	Fl. Orange	1-1/2" x 7/8"	250/Roll
MAP3720	Balance is Due	Fl. Chartreuse	1-1/2" x 7/8"	250/Roll
MAP4170	Past Due Options	Fl. Chartreuse	3-1/4" x 1-3/4"	250/Roll
MAP4180	Patient Responsibility Due	Fl. Chartreuse	3-1/4" x 1-3/4"	250/Roll
UL520	Hate To Keep Hounding	Fl. Pink	2-1/4" x 7/8"	420/Roll

**YOUR INSURANCE COMPANY HAS ALREADY PAID ITS SHARE OF YOUR BILL.** MAP2200  
**WE HAVE NOT BEEN PAID ON THIS CLAIM Because Your Insurance Company:** MAP1560  
**PAST DUE** MAP4170  
**WE HATE TO KEEP HOUNDING YOU, BUT YOUR BILL IS PAST DUE.** UL520  
**PATIENT RESPONSIBILITY DUE TO:** MAP4180

### remind'r' labels

stock no.	description	color	size	labels/roll
40506	Thank You!	Fl. Red	1-1/2" x 3/4"	250/Roll
40508	Final Notice!	Fl. Red	1-1/2" x 3/4"	250/Roll
40524	Medical Alert	Fl. Red	1-1/2" x 3/4"	250/Roll
40525	Allergic To:	Fl. Red	1-1/2" x 3/4"	250/Roll
40526	Pre-Medicare	Fl. Red	1-1/2" x 3/4"	250/Roll
40528	Diabetic	Fl. Red	1-1/2" x 3/4"	250/Roll
40531	Confidential Label	Fl. Red	1-1/2" x 3/4"	250/Roll
40539	Sign Here *Removable	Fl. Red	1-1/2" x 3/4"	250/Roll
40554	Rush *Removable	Fl. Red	1-1/2" x 3/4"	250/Roll

**Thank You!** 40506 **FINAL NOTICE!** 40508 **MEDICAL ALERT** 40524  
**ALLERGIC TO:** 40525 **PRE-MEDICATE** 40526 **DIABETIC** 40528  
**CONFIDENTIAL** 40531 **Sign Here** 40539 **RUSH** 40554



## laser/inkjet label sheets

Multi-use **laser/inkjet label sheets** are useful for mailings, announcements, getting organized, tracking or recalling documents and more. Permanent labels are easy to apply for convenient, personalized labels anytime. Sheets are shrink-wrapped in packages and are fully compatible with both laser and inkjet printers. Labels feed automatically from paper tray and are centered on sheets so they can be fed using either the top or bottom as the lead edge. *See your printer manual for additional feeding instructions.*

**Stock No. 49430**

Matches Avery® No. 5366  
3-7/16" x 2/3"

30 Labels/Sheet - 25 Sheets/Pkg

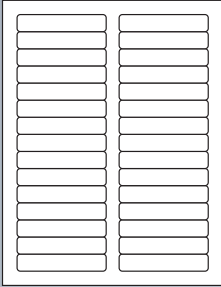

**Stock No. 40150**

Matches Avery® No. 5167  
1-3/4" x 1/2"

80 Labels/Sheet - 100 Sheets/Pkg

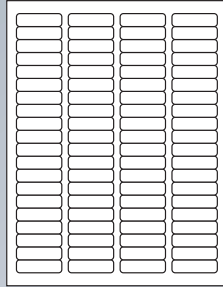

**Stock No. 40151**

Matches Avery® No. 5160  
2-5/8" x 1"

30 Labels/Sheet - 100 Sheets/Pkg

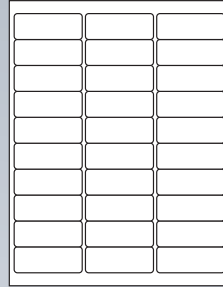

**Stock No. 40152**

Matches Avery® No. 6490  
2-11/16" x 2"

15 Labels/Sheet - 100 Sheets/Pkg

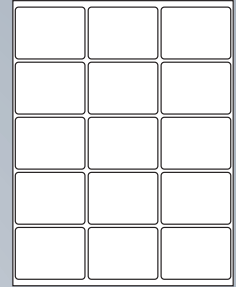

**Stock No. 40153**

2-13/16" x 1-1/2"

21 Labels/Sheet - 100 Sheets/Pkg

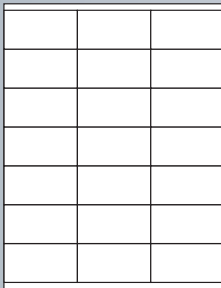

**Stock No. 40156**

Matches Avery® No. 5161  
4" x 1"

20 Labels/Sheet - 100 Sheets/Pkg

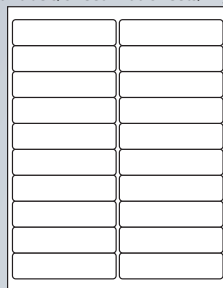

**Stock No. 40157**

Matches Avery® No. 5162  
4" x 1-1/3"

14 Labels/Sheet - 100 Sheets/Pkg

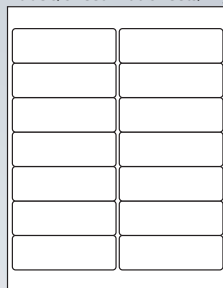

**Stock No. 40158**

Matches Avery® No. 5163  
4" x 2"

10 Labels/Sheet - 100 Sheets/Pkg

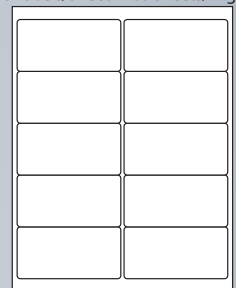

**Stock No. 40159**

4" x 2-1/2"

8 Labels/Sheet - 100 Sheets/Pkg

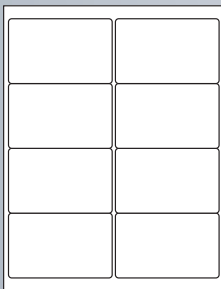

**Stock No. 40160**

Matches Avery® No. 5164  
4" x 3-1/3"

6 Labels/Sheet - 100 Sheets/Pkg

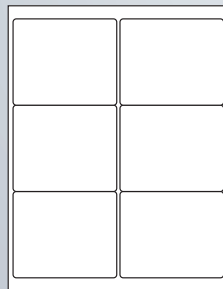

**Stock No. 40161**

4-1/4" x 2-3/4"

8 Labels/Sheet - 100 Sheets/Pkg

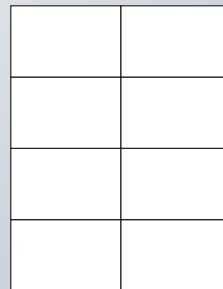

**Stock No. 40162**

4-1/4" x 5-1/2"

4 Labels/Sheet - 100 Sheets/Pkg

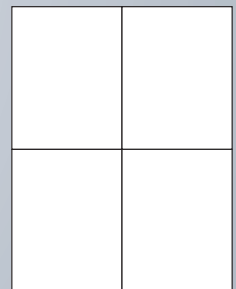

**Stock No. 40163**

8-1/2" x 3-1/2"

3 Labels/Sheet - 100 Sheets/Pkg



**Stock No. 40164**

8-1/2" x 5-1/2"

2 Labels/Sheet - 100 Sheets/Pkg



**Stock No. 40165**

Matches Avery® No. 5165  
8-1/2" x 11"

1 Label/Sheet - 100 Sheets/Pkg

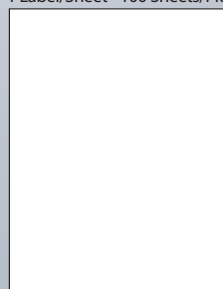

## file folders

**CUSTOM  
PRINTED FOLDERS**  
Call for quote



### 11 pt. 2-Ply Letter

stock no.	size	folders/case
56012	12-1/4" w x 9-1/2" h	500
560121*	12-1/4" w x 9-1/2" h	250
5601213**	12-1/4" w x 9-1/2" h	250
56018	12-1/4" w x 9-1/2" h	500
560181*	12-1/4" w x 9-1/2" h	250
5601813**	12-1/4" w x 9-1/2" h	250
56022	12-1/4" w x 9-1/2" h	500
56023*	12-1/4" w x 9-1/2" h	250
56024**	12-1/4" w x 9-1/2" h	250

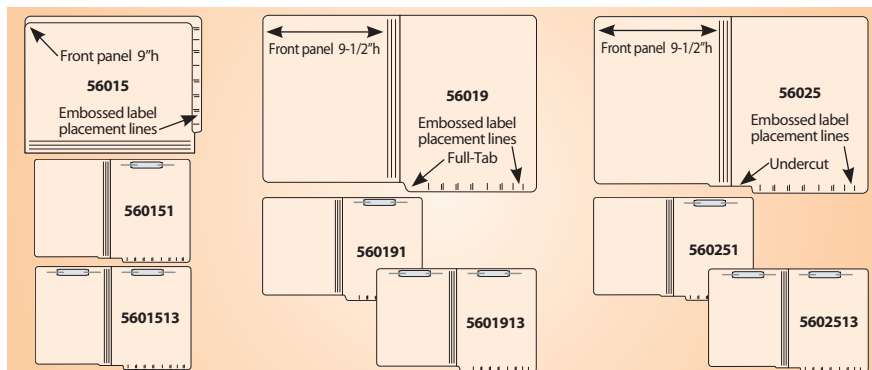

### 14 pt. 2-Ply Letter

stock no.	size	folders/case
56015	12-1/4" w x 9-1/2" h	500
560151*	12-1/4" w x 9-1/2" h	250
5601513**	12-1/4" w x 9-1/2" h	250
56019	12-1/4" w x 9-1/2" h	500
560191*	12-1/4" w x 9-1/2" h	250
5601913**	12-1/4" w x 9-1/2" h	250
56025	12-1/4" w x 9-1/2" h	500
560251*	12-1/4" w x 9-1/2" h	250
5602513**	12-1/4" w x 9-1/2" h	250

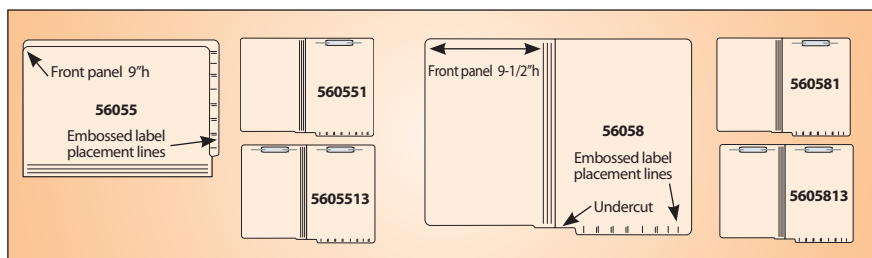

### 15 pt. 2-Ply Legal

stock no.	size	folders/case
56055	15-1/4" w x 9-1/2" h	500
560551*	15-1/4" w x 9-1/2" h	250
5605513**	15-1/4" w x 9-1/2" h	250

### 14 pt. 2-Ply Legal

stock no.	size	folders/case
56058	15-1/4" w x 9-1/2" h	500
560581*	15-1/4" w x 9-1/2" h	250
5605813**	15-1/4" w x 9-1/2" h	250

## combo drawer/shelf file folder

**combination drawer / shelf folder** design can be used as top tab in a drawer or as an end tab in an open shelf. Large tab area on top and side allows plenty of room for all your labeling needs.

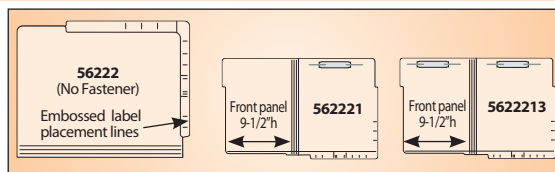

### 11 pt. 2-Ply Letter

stock no.	size	folders/case
56222	12" w x 9-1/2" h	500
562221*	12" w x 9-1/2" h	250
5622213**	12" w x 9-1/2" h	250

## top straight cut file folder

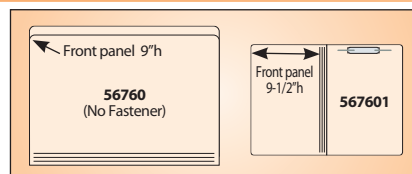
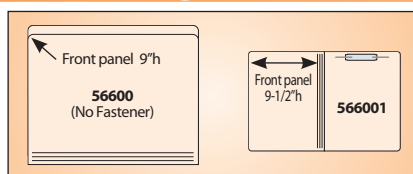

### 11 pt. 1-Ply Letter

stock no.	size	folders/case
56600	11-3/4" w x 9-1/2" h	500
566001*	11-3/4" w x 9-1/2" h	250

### 14 pt. 1-Ply Legal

stock no.	size	folders/case
56760	14-3/4" w x 9-1/2" h	500
567601*	14-3/4" w x 9-1/2" h	250

\* 1 Fastener applied, POSITION 1

\*\* 2 Fasteners applied, POSITIONS 1 & 3.

Printed label placement lines except where noted.

**FASTENER POSITION GUIDE** on page 13 & 19.



## self-adhesive divider sheets

**CUSTOM INDEXING**  
See Page 6

Quickly convert your standard folders to classification folders. Just fold on the score line to create a flap, then remove protective strip and apply to folder—it's that easy! Sturdy **divider sheets** are 11 pt. manila stock. Die-cuts on flap allow for easy positioning around fasteners. **Divider sheets** come in several options: no fastener, 1 fastener on front of divider, or 2 fasteners on both sides of divider. 8-1/2" w x 11" h (not including flap) – 100 dividers per package.

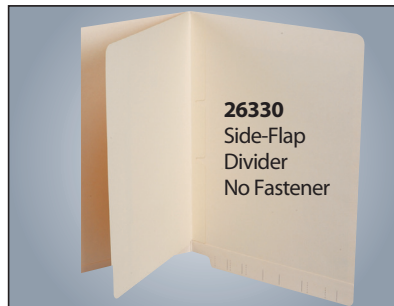

stock no.	fastener(s)
26330	None
263301	1-Fastener Front Top – Pos. #1
2633013	2-Fasteners Top of both sides – Pos. #1 & #3

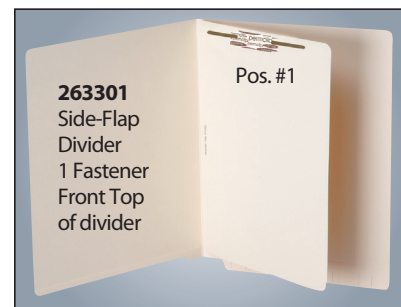

**Fold on score line,  
peel away backing sheet  
and apply to folder**

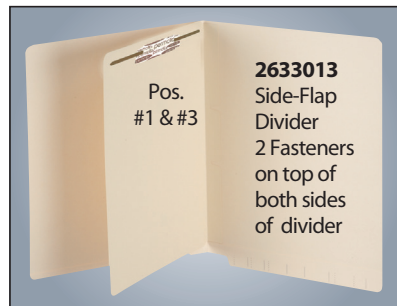

## fileback dividers

**fileback dividers** allow immediate access to each section without removing the top sections from the folder. Each **fileback divider** is scored for easy folding and comes with an installed 2" capacity fastener. Fold score line to form flap and slip divider over existing fastener in folder. The next divider is attached to the fastener on the first divider, and so on. Sturdy 11 pt. manila stock. Available with or without (bottom) end tab cut. 100 dividers per pkg.

stock no.	description
26360	Letter 8-1/2" x 11
26370*	Letter 8-1/2" x 11-3/4"; Left End Tab 1/2 cut
26372*	Letter 8-1/2" x 11-3/4"; Right End Tab 1/2 cut

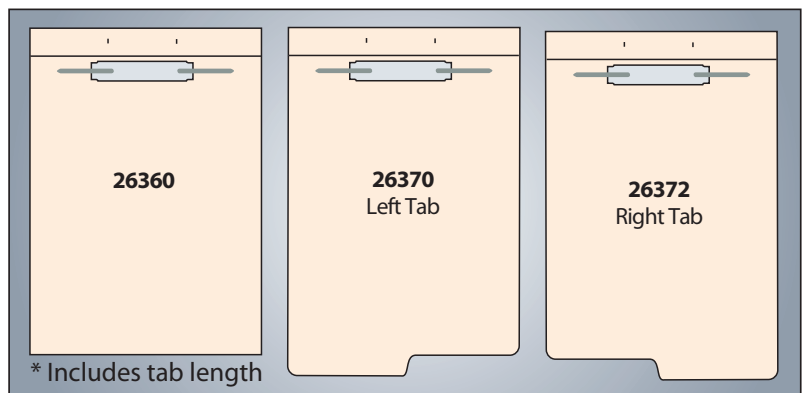

\* 1 Fastener applied, POSITION 1

\*\* 2 Fasteners applied, POSITIONS 1 & 3.

Printed label placement lines except where noted.

**FASTENER POSITION GUIDE** on page 13 & 19.

## conversion products

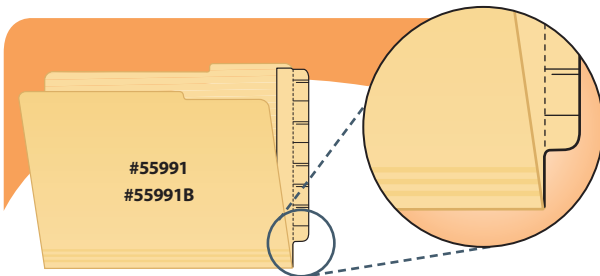

- ◆ Wrap-around design is easy to apply to any top tab folder.
- ◆ Attaches to inside and outside back of folder panel.
- ◆ Manila stock to match your folder.

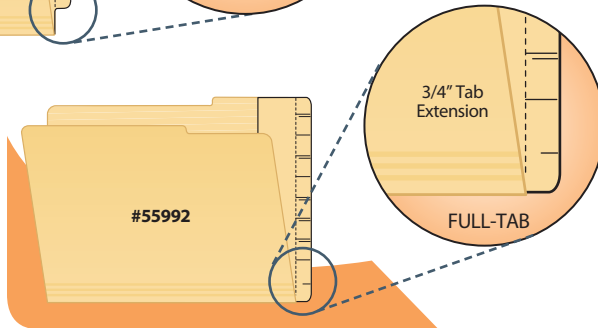

### extenda-folder strips

Convert any top tab pocket folders, pressboard folders, or expanding file jackets into end tab file folders. Save the trouble and expense of transferring materials and throwing away good file folders, pockets, and jackets. All conversion strips are self-adhesive and easy to install. Choose from 6 styles to fit your needs.

stock no.	size	tab extension	strips/box
55991	3-1/4" w x 9-1/4" h	1/2"	100
55991B	3-1/4" w x 9-1/4" h	1/2"	1,000
55992	4-3/4" w x 9-1/2" h	3/4"	100
55993	3-1/4" w x 9-1/2" h	3/4"	100
55993B	3-1/4" w x 9-1/2" h	3/4"	1,000
55994	2" w x 9-1/2" h	3/4"	100
55995	3-3/4" w x 9" h	3/4"	100
55996	3-3/4" w x 9-1/2" h	1"	100

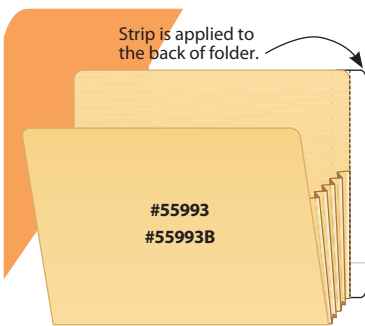

- ◆ Specifically made for pressboard or gusset folders.
- ◆ Labels can be pre-applied before installation of strip.
- ◆ White stock, 3/4" tab extension, 9-1/2" h.

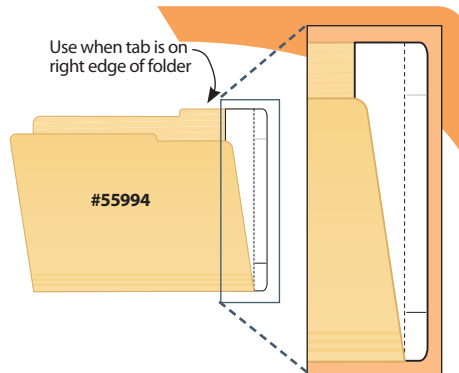

- ◆ 9-1/2" h can be used for any top tab cut folders.
- ◆ Strip is applied inside of the back folder panel.
- ◆ Labels can be pre-applied before installation of strip.
- ◆ White stock, 3/4" tab extension, 9-1/2" h.

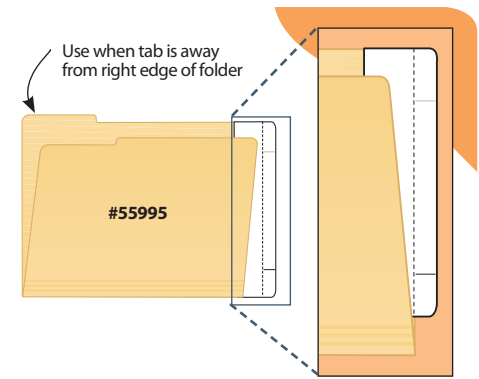

- ◆ 9" h can be used for any top tab cut folders.
- ◆ Strip is applied inside of the back folder panel.
- ◆ Labels can be pre-applied before installation of strip.
- ◆ White stock, 3/4" tab extension, 9" h.

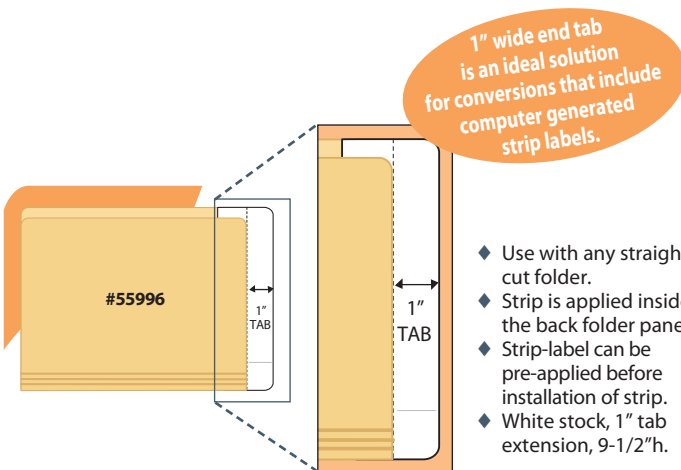

- ◆ Use with any straight cut folder.
- ◆ Strip is applied inside of the back folder panel.
- ◆ Strip-label can be pre-applied before installation of strip.
- ◆ White stock, 1" tab extension, 9-1/2" h.

## cov'r'tabs

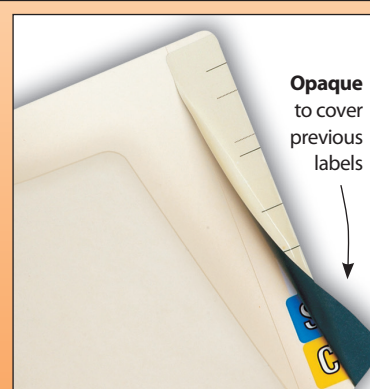

- ◆ Easy way to re-use old folders.
- ◆ Self-adhesive and wrap-around design adds reinforcement to tab.
- ◆ Printed score marks for even positioning of new labels.
- ◆ 60 lb. in manila color finish.
- ◆ Strip must be applied to folder *before* application of new labels.

stock no.	size	cov'r'tabs/pkg.
55990	2-1/2" w x 8" h	50



## sup'r grip fasteners



Self-adhesive **sup'r grip fasteners** are an ideal space-saving solution for large files. Long 2" prongs accommodate 2-hole punched material, while the ultra-thin design saves valuable filing space. Fasteners are heat bonded onto pressure-sensitive, 60 lb. manila-colored paper to hold even the bulkiest files without tearing. Printed aligning guides on each strip ensure accurate placement. 4 fasteners per sheet; 25 sheets per box.

stock no.	description	fasteners/box
56805	sup'r grip fasteners	100

## earflap™ fasteners



Turn existing file folders into classification folders easily and inexpensively. Section files by date, subject or other criteria that fit your needs.

Slip the punched flap over an existing fastener and close the prongs. Fold flap forward and add filing material to the bonded fastener on top of the manila strip. **earflap™ fasteners** work with any two-prong fastener in all folder positions.

stock no.	description	fasteners/box
56809	earflap fasteners	50

## factory installed fasteners

**permclip® fasteners** are heat-bonded for permanent adhesion to the file folder. **permclip® fasteners** are factory installed in any position to fit your filing needs. Prongs are 2" in length and 2-3/4" center to center. Please specify fastener position from the position guide at the time of order.

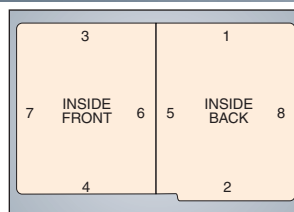

Fastener Position Guide

stock no.	description
56811	one bonded fastener per folder
56812	two bonded fasteners per folder

## foamclip® fasteners



Self-adhesive **foamclip® fasteners** are a perfect choice for organizing any 2-hole punched papers. These fasteners bond permanently to file folders, pressboard, plastic, wood, glass, even metal. With their superior strength, **foamclip® fasteners** can't be pulled off like other brands! The 2-3/4" center-to-center, 1-1/2" capacity fastener is easy to use; just peel off backing paper and press fastener into place.

stock no.	description	fasteners/box
56807	foamclip fasteners	100

## jalemaclip fasteners

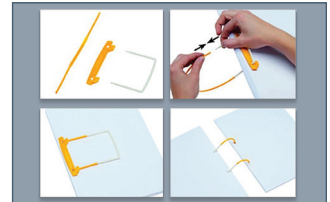

**jalemaclip fasteners** are 5" capacity fasteners that allow you to access any part of the file without having to remove the file contents. Make notes, copy or review the pages within the file quickly and easily. For use with 2-hole punched documents. Holes are positioned 2-3/4", center-to-center. Sets consist of self-adhesive bases, compressor bars and u-shaped extensions.

stock no.	description	fasteners/box
56804	jalemaclip fasteners	100

## u-file-m binder strips

**u-file-m binder strips** make each folder read like a book. Documents are affixed to a strip of tabs in either ascending or descending order. File by either older information first, or by newer information on top. Instructions included. Permanent adhesive.

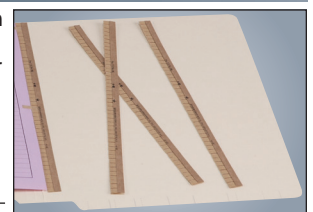

stock no.	description	strips/box
56820	u-file-m binder strip	100

Strip holds up to 22 sheets.

Any of the above stock fasteners can be factory installed to fit your filing needs.

Choose your fastener position from the position guide above.

Also see Page 21  
2-Hole  
Reinforcing Strips

## laser / inkjet file folder labels

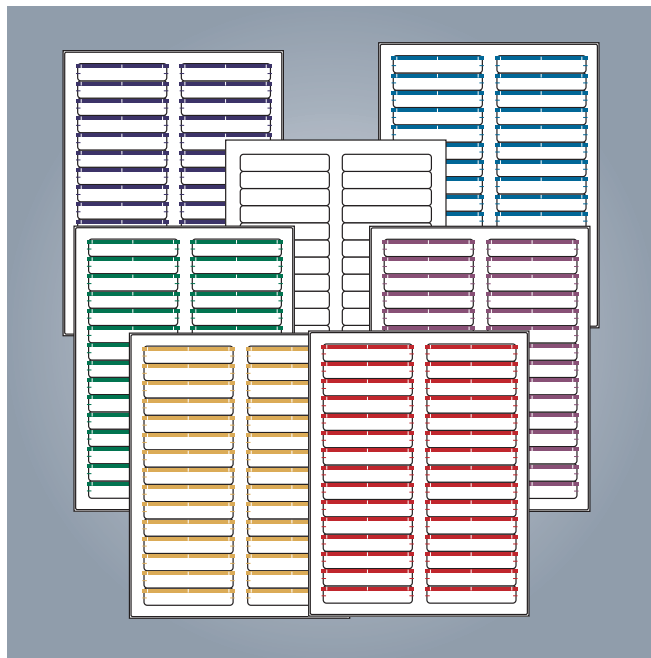

**laser / inkjet file folder labels** are easy to use with most label software. The paper and adhesive are formulated specifically for use in laser or inkjet printers. 750 labels per package. Labels are 2-up per page. Overall sheet size: 8-1/2" w x 11" h

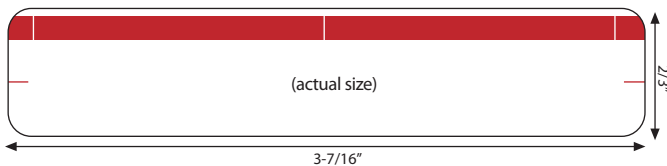

### Avery #5366 Laser/Inkjet File Folder Labels compatible series

stock no.	color	labels/sheet	sheets/pkg.
49430	White	30	25
49431	Light Blue	30	25
49432	Red	30	25
49436	Green	30	25
49437	Dark Blue	30	25
49441	Tan	30	25
49443	Purple	30	25

## file folder labels

Self-adhesive **file folder labels** attach permanently to file folders, cards, etc. Color coded for easy identification and smudge proof for legibility. Available in convenient sheets, in white and 6 colors ready for writing or typing. Labels are 3-7/16" w x 9/16" h in size. Labels are 1-up per page.



*Writable only. This product is not intended for use with printer.*

stock no.	color	labels/pkg.
59430	White	248
59431	Light Blue	248
59432	Red	248
59436	Green	248
59437	Dark Blue	248
59441	Tan	248
59443	Purple	248

## wrap-around file folder labels

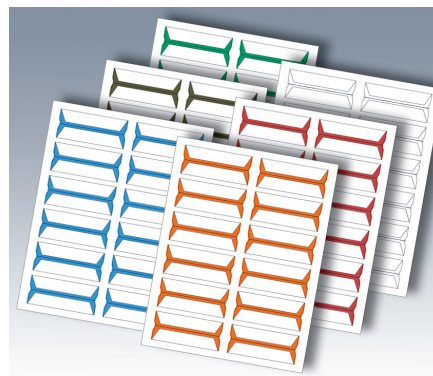

Use Microsoft Word® and any laser/inkjet printer to create **wrap-around file folder labels** for file folders, pockets, jackets, etc. Easy set-up instructions for both drawer and shelf filing applications in each package. 8-1/2" w x 11" h sheets.

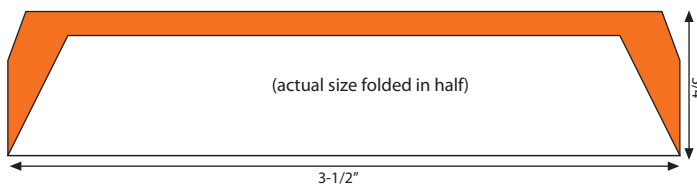

### Acme® Abgor File Folder Labels compatible series

stock no.	color	labels/sheet	labels/pkg.
49401	Azure Blue	12	240
49402	Brown	12	240
49403	Green	12	240
49404	Orange	12	240
49405	Red	12	240
49406	White	12	240



## name label protectors

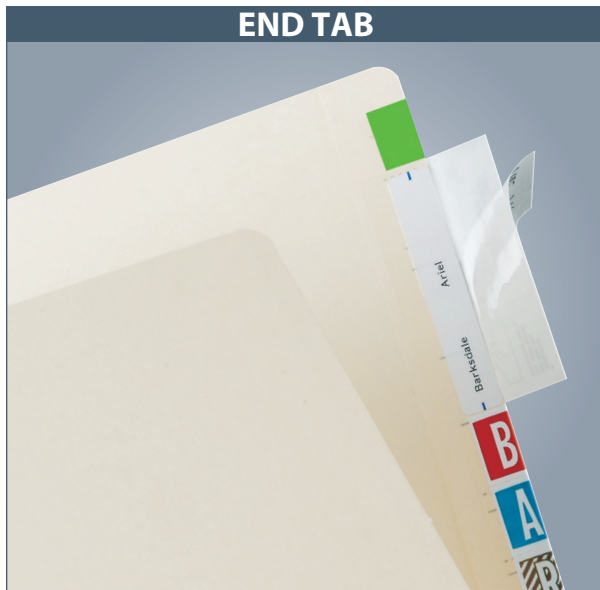

**name label protectors** eliminate dirty, worn, dog-eared file folders and file folder labels. Clear, wrap-around, self-adhesive protectors keep file folders and labels clean and prevent them from falling off, extending the life of the folder.

**name label protectors** can also be used "flat" to attach miscellaneous materials to any surface.

stock no.	protectors/ size	pkgs./ pkg.	protectors/ box	roll
58385	3-1/2"w x 2"h	100	5	–
58485	4"w x 2"h	100	5	–
58385B	3-1/2"w x 1-3/4"h	–	500*	–
88385	3-1/2"w x 2"h	–	–	500
88485	4"w x 2"h	–	–	500

\*500 single protectors per box



## full end tab protectors



**end tab protectors** are an ideal solution for extending the life of shelf file folders. Clear protectors wrap around folder end tabs, preventing labels from cracking or popping off, and protect against wear and tear.

Self-adhesive, 8" x 2" protectors can be easily applied to all types of end tab file folders to keep them looking neat and clean longer.

stock no.	size	protectors/pkg.
68386	8"h x 2"w	100

## spine edge protectors



**edge protectors** keep heavily used file folders looking good longer by protecting edges from cracking or splitting. The 11" x 2" clear, wrap-around protector is easily applied to the bottom edge of a file folder, where the most wear and tear occurs as the folder is moved in and out of shelf file cabinets.

stock no.	size	protectors/pkg.
68387	11"w x 2"h	100

*All of the above products can also be used to reinforce documents and page edges that require hole punching and insertion into binders or folders with fasteners. Simply follow the easy application instructions on the pack of each strip, then punch the document as needed.*

## lock-it pockets

Durable, clear polyethylene ziplock style secures small documents, including photos, flash drives, CD's, x-rays and much more. Peel off self-adhesive 5 mil poly pocket. Permanently apply to your folders or wherever it is most convenient. Clear front keeps important information at full view without opening the pocket.



stock no.	inside	outside	pockets/box
54470	5"w x 5-1/4"h	5-1/2"w x 6-1/4"h	100
54471	6"w x 9"h	6-1/2"w x 10"h	100

First dimension is the pocket opening

## poly & vinyl pockets

Clear see-thru pockets are available in several sizes to fit all your needs. It's easy to add a pocket to your file or binder; simply peel off the protective backing and apply the self-adhesive side to your folder. Pockets are sealed on three sides. Store x-rays, forms, immunization records, flash drives, CD's and more.

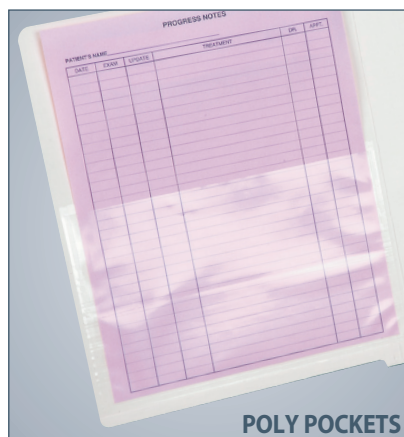

**POLY POCKETS**

Poly pockets provide easy access to information.

### Poly Pockets

stock no.	inside	outside	pockets/box
54495	2-1/2"w x 3-1/4"h	3"w x 3-3/4"h	100
54496	10-1/2"w x 8-1/2"h	11"w x 9"h	100
54497	5"w x 3"h	5-3/4"w x 3-3/4"h	100
54498	6-1/2"w x 4-1/4"h	7"w x 4-3/4"h	100
54499	8-3/4"w x 5-1/2"h	9-1/4"w x 6"h	100

### Vinyl Pockets

stock no.	inside	outside	pockets/box
54492	8-3/4"w x 11-1/4"h	9"w x 11-1/2"h	100
54493	5-1/4"w x 3-1/4"h	5-1/2"w x 3-1/2"h	100
54494	8-3/4"w x 5-1/2"h	9"w x 5-3/4"h	100

First dimension is the pocket opening

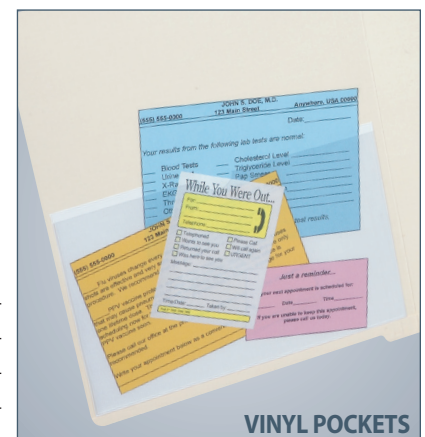

**VINYL POCKETS**

Vinyl pockets are textured and heavy-duty.

## expanding divider pockets

Strong 40 lb. Kraft pocket has a thumbcut opening for easy access. Reinforced binding holes are pre-punched to be used with fastener folder. Letter or legal size application. Pocket has a 1" expansion.

stock no.	description	pockets/box
54460	divider pockets	100





Also see Page 17  
Fasteners

## reinforcing strips

**5-hole reinforcing strips** are made of tear resistant material, pre-punched and ready to use. Clear strips will not hide printed information. The **5-hole reinforcing strips** can be used in one of three ways.

Add durability and longevity to your documents with our **2-hole reinforcing strips**. Strips are self-adhesive for easy use. Material is tear resistant and clear so it will not hide printed information.

stock no.	description	strips/pkg.	pkgs./box
58390	11" 5-hole punched 2" overall (1" pulled apart)	20	10
58392	3-1/2" 2-hole punched	500 strips (bulk)	

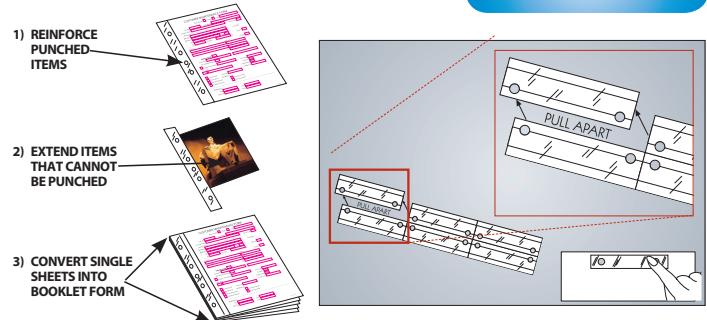

## Media Storage DVD/CD Saver™ Sleeve Protectors



Protect DVD/CD in these smooth, durable polypropylene sleeves in stylish, translucent colors. DVD/CDs stay clean and organized, and a tuck-in flap holds DVD/CDs more securely than an open pocket. **DVD/CD Saver Sleeve Protectors** come with self-adhesive labels for built-in index tabs.

stock no.	description	sleeves/pkg.	pkgs./carton
25100	Assorted	10	12
25101	Clear	25	10

## outguides

**vinyl outguides** are flexible enough for easy handling, yet resist cracking and tearing. Double sided "OUT" tab extends beyond folder for easy access. Clear vinyl pocket holds charge-out slips. Heavy duty outguides feature large tabs, a rigid vinyl back and stress contours on pockets to provide added strength and durability for frequent handling.

Call to inquire about other available colors.

### charge-out slips

**charge-out slips** keep track of removed folder, when used with outguide. 100 sheets/pad.

stock no.	size	pads/box
74559	5" w x 3" h	10

FILE NAME/NUMBER \_\_\_\_\_  
 DATE OUT \_\_\_\_\_ DATE RETURN \_\_\_\_\_  
 NAME (PRINT) \_\_\_\_\_ DEPT. \_\_\_\_\_  
 SIGNATURE \_\_\_\_\_  
INSERT THIS CHARGE-OUT FORM INTO THE POCKET ON THE OUTGUIDE AND REPLACE CHARGE-OUT FOLDER WITH OUTGUIDE. NOTE: DUPLICATE CHARGE-OUT FORMS CAN BE USED FOR FOLLOWUP PURPOSES. IN FILE NAME/NUMBER ORDER OR "DATE TO RETURN" ORDER.  
 TABBIES STOCK NO. 74559

### center tab

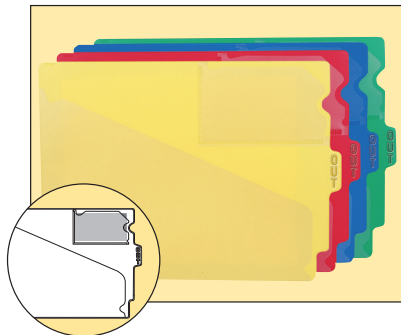

- ◆ "OUT" is embossed on both sides of tab
- ◆ Overall size: 9-1/2" h x 12-7/8" w
- ◆ Body size: 9-1/2" h x 12-3/8" w

stock no.	color	size	guides/pkg.
74500	Red	Letter	10
74501	Blue	Letter	10
74502	Green	Letter	10
74504	Yellow	Letter	10
74520*	Red	Legal	10

\*Legal size: Overall size: 9-1/2" x 15-3/4"  
Body size: 9-1/2" x 15-1/4"

### bottom tab

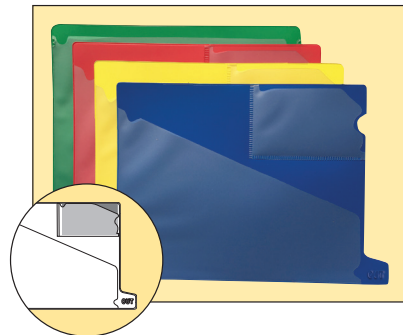

- ◆ "OUT" is embossed on the tab
- ◆ Overall size: 9-1/2" h x 13-1/4" w
- ◆ Body size: 9-1/2" h x 11-7/8" w

stock no.	color	guides/pkg.
74530	Red	10
74531	Blue	10
74532	Green	10
74534	Yellow	10

### large tab

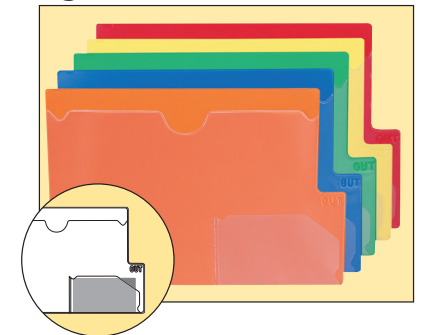

- ◆ "OUT" is embossed on the tab
- ◆ Overall size: 9" h x 13-1/4" w
- ◆ Body size: 9" h x 12" w

stock no.	color	guides/pkg.
74580	Red	10
74581	Blue	10
74583	Orange	10
74584	Yellow	10
74585	Green	10

## custom installation solutions

Save time and money... choose any of our stock or custom products to fit your filing needs and let us do the custom installation work.

**Tabs/Labels**

**Pockets**

**Fasteners**

**Indexes**

**Filebacks**

**u-file-m Strips**

**Conversion Strips**

**Dividers**

**Index Tab Divider Positions**

**Right End Tab Folder**

**Top Tab Folder**

**CALL FOR QUOTE**

## custom labels

TABBIES has been printing and converting high quality labels and films for packaging and commercial industrial products since 1985. We stock a wide variety of materials, dies and adhesives. We provide paper and film solutions that help you create compelling graphics that project a strong presence and increase brand recognition.



### CAUTION/ALERT LABELS:

**BIOHAZARD AUTOCLAVE BEFORE DISPOSAL**

**SHARPS DISPOSAL ONLY**

### COLOR CODE LABELS:



### PROMOTIONAL/MARKETING LABELS

**ICE MEDICAL ALERT CARD**

ALERTS:

- ADVANCE DIRECTIVE
- ASTHMA
- DIABETIC
- HEARING IMPAIRED
- IMPLANTS
- NO EPINEPHRINE ON ANTI-COAGULANTS
- PACEMAKER
- PREMENOPAUSE
- STROKE PATIENT
- OTHER

ALLERGIC TO:

- PENICILLIN
- COCAINE
- SULFA

NAME: \_\_\_\_\_ TEL # \_\_\_\_\_

DR. NAME: \_\_\_\_\_ TEL # \_\_\_\_\_

PHARMACY: \_\_\_\_\_ TEL # \_\_\_\_\_

**MED CARD**

DATE	DATE	DOSE	FREQUENCY

**I ALSO TAKE:**

- OVER THE COUNTER
- HERBALS
- EYE DROPS
- SUPPLEMENTS
- VITAMINS
- INHALERS

NAME: \_\_\_\_\_ TEL # \_\_\_\_\_

DR. NAME: \_\_\_\_\_ TEL # \_\_\_\_\_

PHARMACY: TEL # \_\_\_\_\_

EMERGENCY CONTACT: \_\_\_\_\_

NAME: \_\_\_\_\_ TEL # \_\_\_\_\_

### BLANK LABELS:

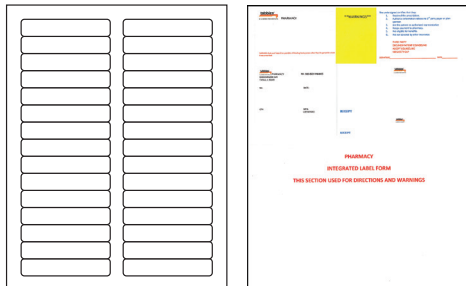

### THERMAL TRANSFER LABELS:









## original col'r'tab® color code labels

Original Col'RTab® color code labels provide the best value of any label system in the industry. The unique hinged construction allows for consistent and quick application to file folders, pockets, or even pressboard folders. The clear, outside skirt offsets any tendency for the labels to "hook" onto one another when pulled from the shelf. Made with heavy duty paper and fade-resistant inks. Do not settle for inexpensive color matches – realize the value and savings by using only original Col'RTab products!



12001 – Roll 82001 – Pkg.	12002 – Roll 82002 – Pkg.	12003 – Roll 82003 – Pkg.	12004 – Roll 82004 – Pkg.	12005 – Roll 82005 – Pkg.	12006 – Roll 82006 – Pkg.	12007 – Roll 82007 – Pkg.
12008 – Roll 82008 – Pkg.	12009 – Roll 82009 – Pkg.	12010 – Roll 82010 – Pkg.	12011 – Roll 82011 – Pkg.	12012 – Roll 82012 – Pkg.	12013 – Roll 82013 – Pkg.	12014 – Roll 82014 – Pkg.
12015 – Roll 82015 – Pkg.	12016 – Roll 82016 – Pkg.	12017 – Roll 82017 – Pkg.	12018 – Roll 82018 – Pkg.	12019 – Roll 82019 – Pkg.	12020 – Roll 82020 – Pkg.	12021 – Roll 82021 – Pkg.
12022 – Roll 82022 – Pkg.	12023 – Roll 82023 – Pkg.	12024 – Roll 82024 – Pkg.	12025 – Roll 82025 – Pkg.	12026 – Roll 82026 – Pkg.	12027 – Roll 82027 – Pkg.	

### 12000 / 82000 series Original Col'RTab®

1"H x 1-1/2"W – Label size

**ROLL** / 500 labels per roll  
**Roll Unit** – 42000 (28 rolls)

**PACK** / 100 labels per pkg.  
10 labels per strip  
Sheet size: 10" x 1-1/2"

**Desktop Kit** – 32000 (3,200 labels)

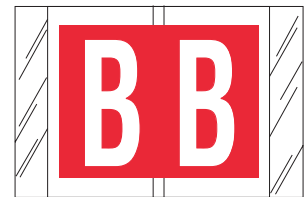

Dispenser Container only – 12000  
(Holds 30 Rolls)

12030 – Roll 82030 – Pkg.	12031 – Roll 82031 – Pkg.	12032 – Roll 82032 – Pkg.	12033 – Roll 82033 – Pkg.	12034 – Roll 82034 – Pkg.	12035 – Roll 82035 – Pkg.	12036 – Roll 82036 – Pkg.
12037 – Roll 82037 – Pkg.	12038 – Roll 82038 – Pkg.	12039 – Roll 82039 – Pkg.	12040 – Roll 82040 – Pkg.	12041 – Roll 82041 – Pkg.	12042 – Roll 82042 – Pkg.	

Can be used  
with 12000  
Series A-M  
labels

### 12030 / 82030 series Original Col'RTab®

1"H x 1-1/2"W – Label size

**ROLL** / 500 labels per roll  
**Roll Unit** – 42030 (28 rolls)

**PACK** / 100 labels per pkg.  
10 labels per strip  
Sheet size: 10" x 1-1/2"

**Desktop Kit** – 32030 (3,200 labels)

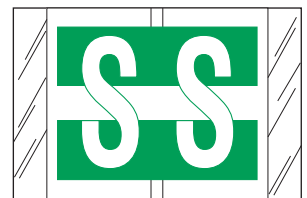

### 11000 / 81000 series Original Col'RTab®

1"H x 1-1/2"W – Label size

**ROLL** / 500 labels per roll  
**Roll Unit** – 41000 (10 rolls)

**PACK** / 100 labels per pkg.  
10 labels per strip  
Sheet size: 10" x 1-1/2"

**Desktop Kit** – 31000 (4,000 labels)

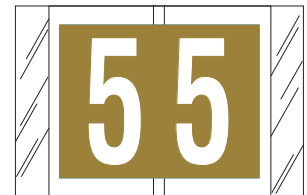

Dispenser Container only – 12000  
(Holds 30 Rolls)

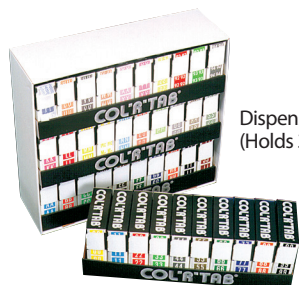

Dispenser Container only – 11015  
(Holds 10 Rolls)

11000 – Roll 81000 – Pkg.	11001 – Roll 81001 – Pkg.	11002 – Roll 81002 – Pkg.	11003 – Roll 81003 – Pkg.	11004 – Roll 81004 – Pkg.
11005 – Roll 81005 – Pkg.	11006 – Roll 81006 – Pkg.	11007 – Roll 81007 – Pkg.	11008 – Roll 81008 – Pkg.	11009 – Roll 81009 – Pkg.

## original col'r'tab® color code labels

### 12100 / 82100 series

#### Original Col'R'Tab®

1-1/2"H x 1-1/2"W – Label size

**ROLL** / 500 labels per roll

**Roll Unit** – 42100 (28 rolls)

**PACK** / 104 labels per pkg.

8 labels per strip

Sheet size: 12" x 1-1/2"

**Desktop Kit** – 32100 (3,200 labels)

Dispenser Container only – 12000  
(Holds 30 Rolls)

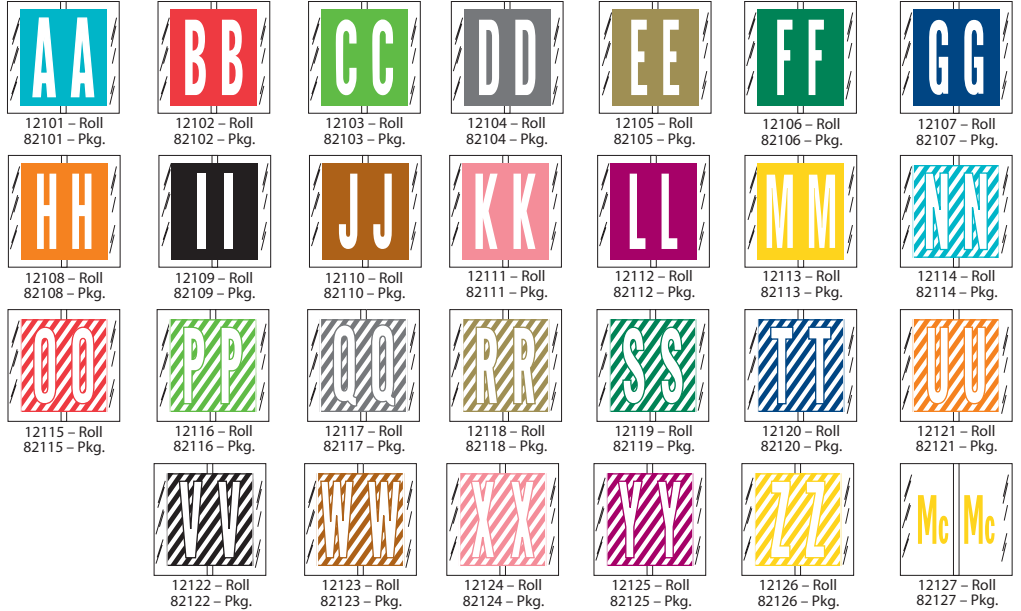
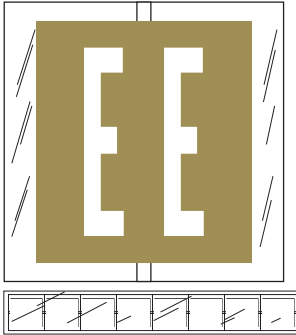
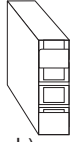

### 11500 / 81500 series

#### Original Col'R'Tab®

1-1/2"H x 1-1/2"W – Label size

**ROLL** / 500 labels per roll

**PACK** / 104 labels per pkg.

8 labels per strip

Sheet size: 12" x 1-1/2"

Dispenser Container only – 11015  
(Holds 10 Rolls)

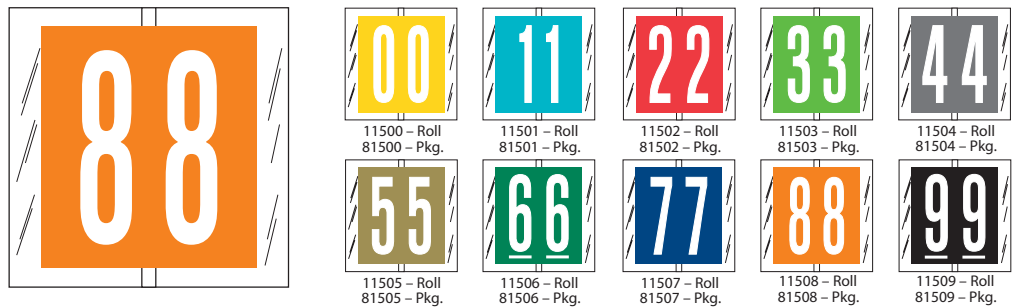
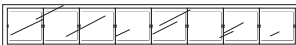

### 82050 series

#### Original Col'R'Tab®

1-1/2"H x 1"W (Top Tab) – Label size

**PACK** / 100 labels per pkg.

10 labels per strip

Sheet size: 10" x 1-1/2"

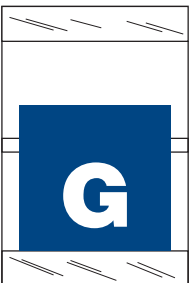

### 11050 series

#### Original Col'R'Tab®

1-1/2"H x 1"W (Top Tab) – Label size

**ROLL** / 500 labels per roll

Dispenser Container only – 11015  
(Holds 10 Rolls)

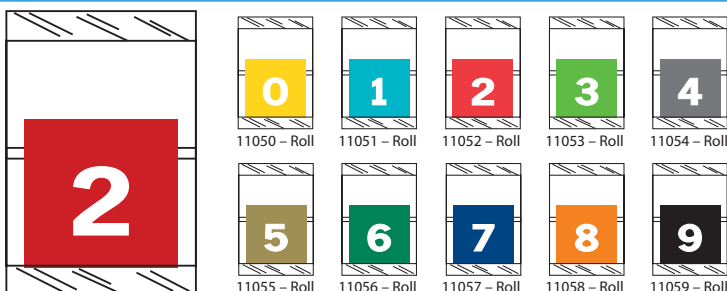
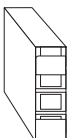

## original col'r'tab® color code labels

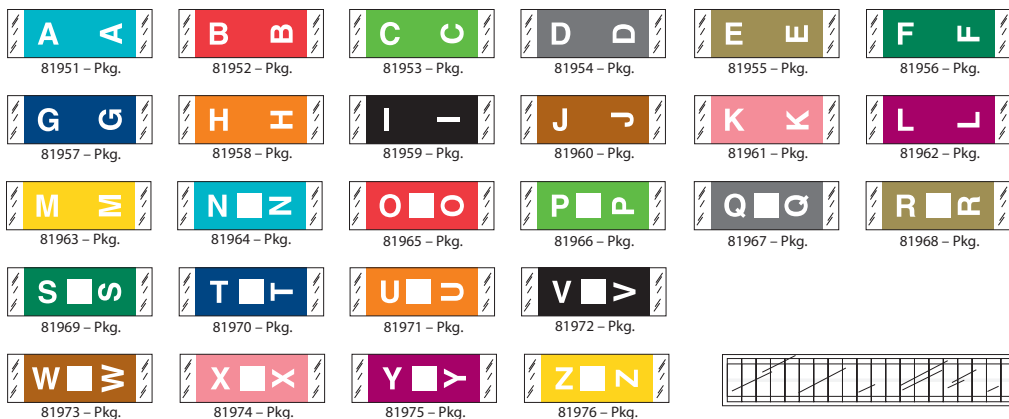

**81950 series**  
Original Col'R'Tab®  
1/2"H x 1-1/2"W – Label size  
**PACK** / 100 labels per pkg.  
20 labels per strip  
Sheet size: 10" x 1-1/2"  
**Desktop Kit** – 31950 (3,100 labels)

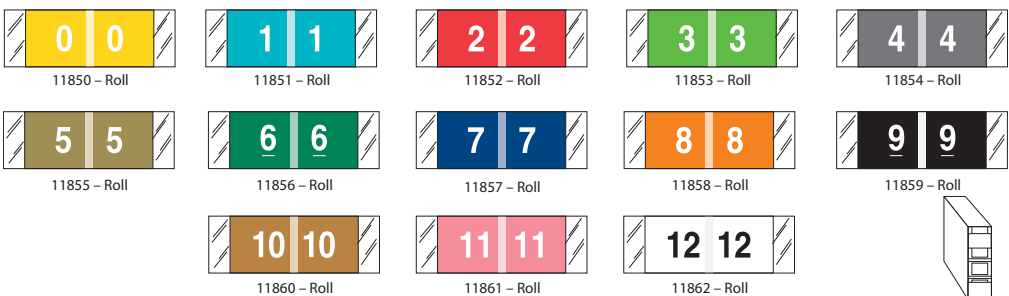

**11850 series**  
Original Col'R'Tab®  
1/2"H x 1-1/2"W – Label size  
**ROLL** / 500 labels per roll

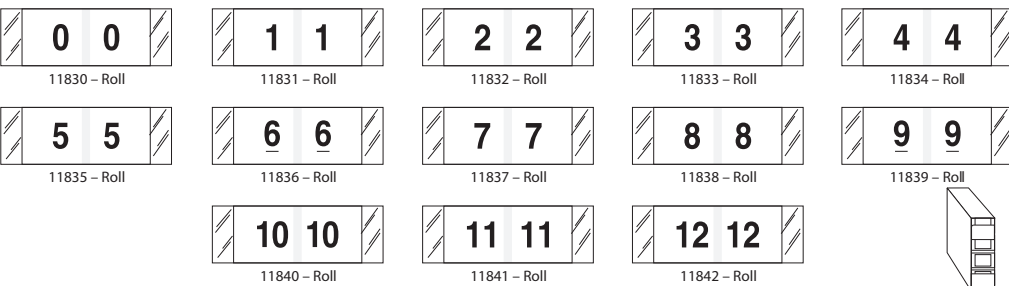

**11830 series**  
Original Col'R'Tab®  
1/2"H x 1-1/2"W – Label size  
**ROLL** / 500 labels per roll

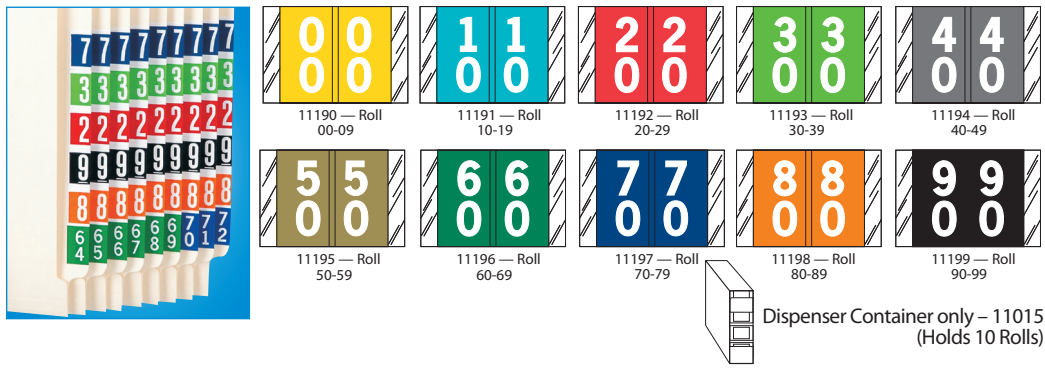

**11200 series**  
Original Col'R'Tab®  
1"H x 1-1/2"W – Label size  
**ROLL** / 500 labels per roll  
**Roll Unit** – 11200 (10 rolls)

Dispenser Container only – 11015 (Holds 10 Rolls)

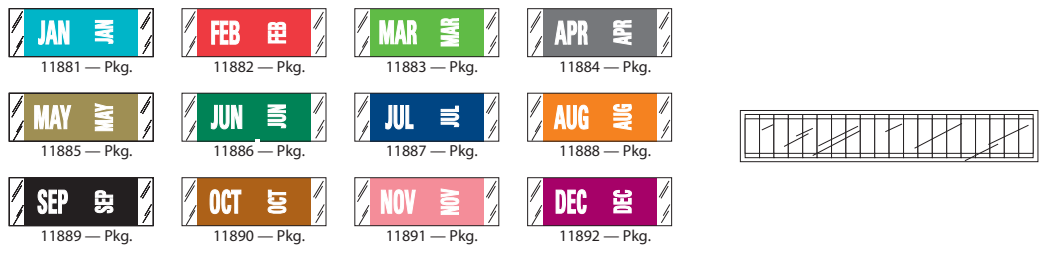

**11880 series**  
Original Col'R'Tab®  
1/2"H x 1-1/2"W – Label size  
**PACK** / 100 labels per pkg.  
20 labels per strip  
Sheet size: 10" x 1-1/2"



## compatible color code labels

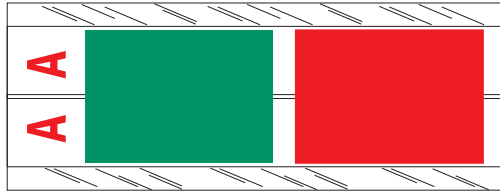
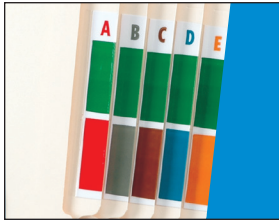

**12700 series**  
Acme Visible® compatible series

4"H x 1-1/2"W – Label size

**PACK** / 102 labels per pkg.

3 labels per strip

Sheet size: 12" x 1-1/2"

Original Col'RTab® construction

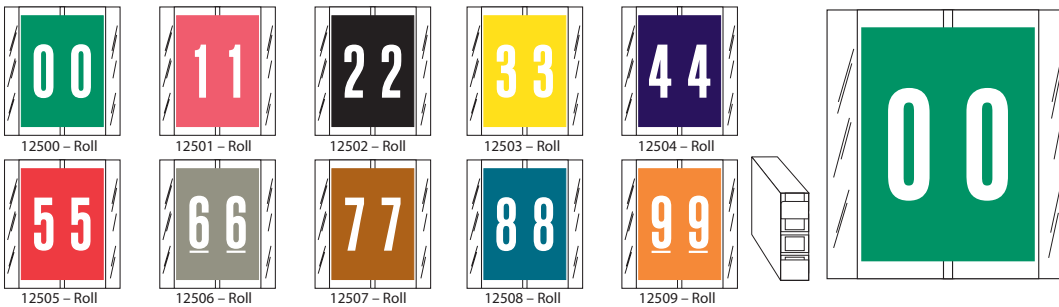

**12500 series**  
Acme Visible® compatible series

1-2/3"H x 1-1/2"W – Label size  
Original Col'RTab® construction

**ROLL** / 500 labels per roll

Dispenser Container only – 11015  
(Holds 10 Rolls)

**Call for availability on  
double digit labels.**

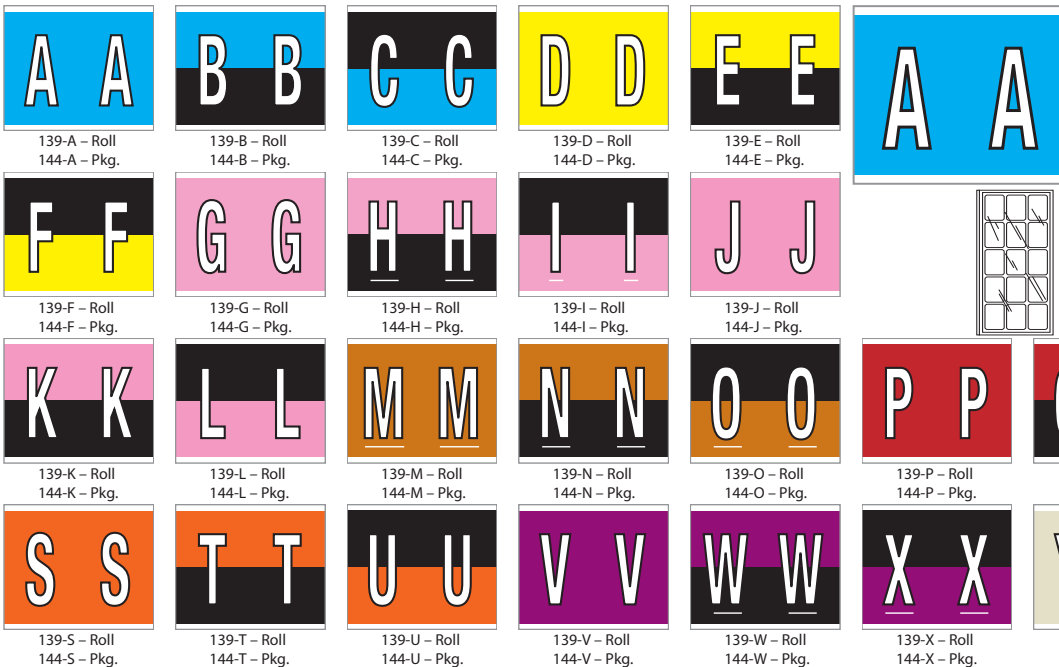

**139 & 144 series**  
Kardex® compatible series

1-1/4"H x 1-1/2"W – Label size

**ROLL** / 500 labels per roll

**PACK** / 210 labels per pkg.

15 labels per sheet

Sheet size: 4-13/16" x 6-7/8"

## compatible color code labels

### 138 / 140 series Kardex® compatible series

**138 series**  
1-1/4"H x 1-1/2"W – Label size  
**ROLL** / 500 labels per roll

**140 series**  
1/2"H x 1"W – Label size  
**ROLL** / 1500 labels per roll

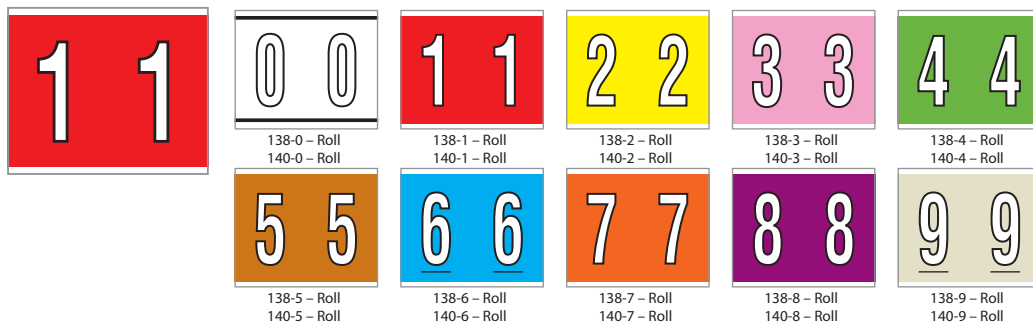

### 91620 / 71620 series Barkley® ABKM compatible series

1"H x 1-1/2"W – Label size  
**ROLL** / 500 labels per roll  
**Roll Unit** – 31620 (28 rolls)  
Dispenser Container only – 90150  
(Holds 28 Rolls)  
**PACK** / 252 labels per pkg.  
9 labels per sheet  
Sheet size: 5" x 3-3/8"  
**Desktop Kit** – 71620 (2,016 labels)

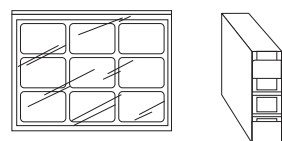
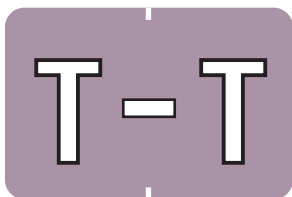

### 91600 / 71600 series Barkley® NBKM compatible series

1"H x 1-1/2"W – Label size  
**ROLL** / 500 labels per roll  
**Roll Unit** – 31600 (10 rolls)  
Dispenser Container only – 90110  
(Holds 10 Rolls)  
**PACK** / 252 labels per pkg.  
9 labels per sheet  
Sheet size: 5" x 3-3/8"

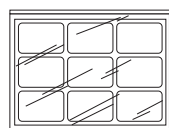
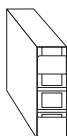

## compatible color code labels



**91420 / 61420 series**  
Colwell® Jewel-Tone compatible series

1"H x 1-1/2"W – Label size

**ROLL** / 500 labels per roll  
**Roll Unit** – 91420 (28 rolls)

Dispenser Container only – 90150  
(Holds 28 Rolls)

**RINGBOOK** / 240 labels per pkg.  
24 labels per sheet / 3 drill holes  
Sheet size: 5-1/2" x 9"

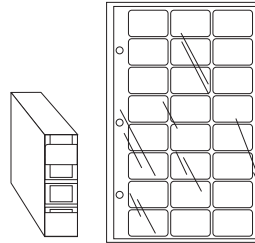

**91400 series**  
Colwell® Jewel-Tone compatible series

1"H x 1-1/2"W – Label size

**ROLL** / 500 labels per roll  
**Roll Unit** – 91410 (10 rolls)

Dispenser Container only – 90110  
(Holds 10 Rolls)

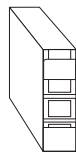
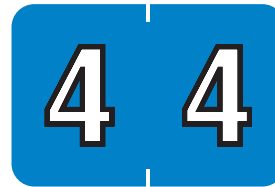

**91320 / 61320 series**  
GBS® / VRE® 8848/8850 compatible series

1-5/16"H x 1-1/4"W – Label size

**ROLL** / 550 labels per roll  
**Roll Unit** – 91320 (27 rolls)

**RINGBOOK** / 200 labels per pkg.  
10 labels per sheet / 6 drill holes  
Sheet size: 3-1/4" x 6-3/4"

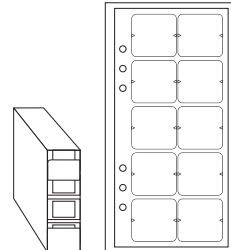

**91300 series**  
GBS® / VRE® compatible series

1-5/16"H x 1-1/4"W – Label size

**ROLL** / 550 labels per roll  
**Roll Unit** – 91310 (10 rolls)





## compatible color code labels

### 14610 series GBS® / VRE® compatible series

1-5/16"H x 1-1/2"W – Label size  
Original Col'R'Tab® construction

**ROLL** / 500 labels per roll

Dispenser Container only – 12000  
(Holds 30 Rolls)

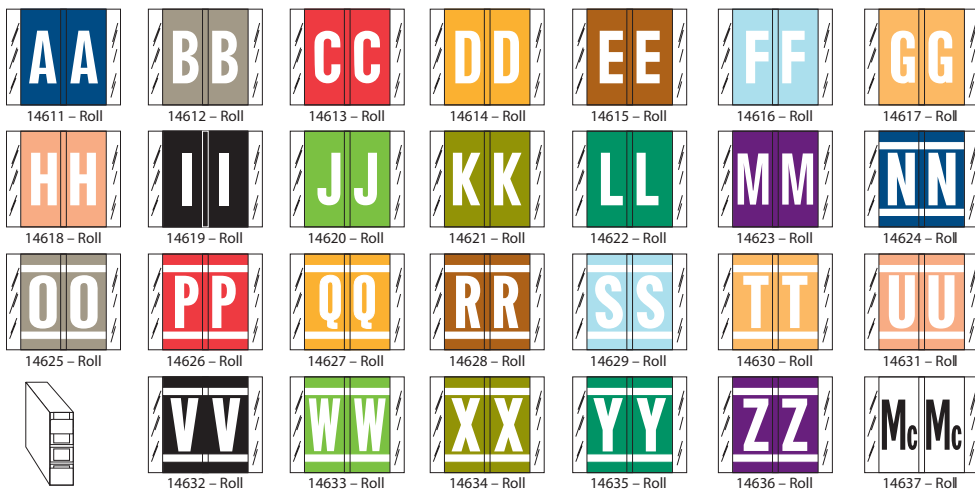
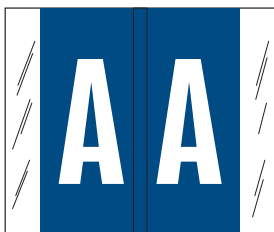

### 14600 series GBS® / VRE® compatible series

1-5/16"H x 1-1/2"W – Label size  
Original Col'R'Tab® construction

**ROLL** / 500 labels per roll

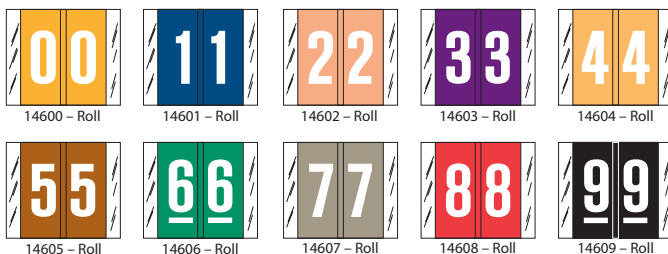
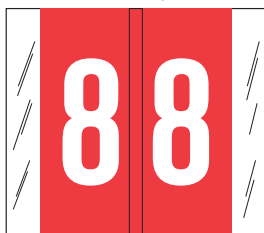

call for availability on double digit labels

Dispenser Container only – 11015  
(Holds 10 Rolls)



### 91120 / 71120 series Tab Products® & Jeter® 5100 compatible series

15/16"H x 1-1/2"W – Label size  
Laminated finish

**ROLL** / 500 labels per roll

**Roll Unit** – 31120 (28 rolls)

**PACK** / 252 labels per pkg.

9 labels per sheet

Sheet size: 5" x 3-1/2"

**Desktop Kit** – 71120 (2,016 labels)



Dispenser Container only – 90150  
(Holds 28 Rolls)

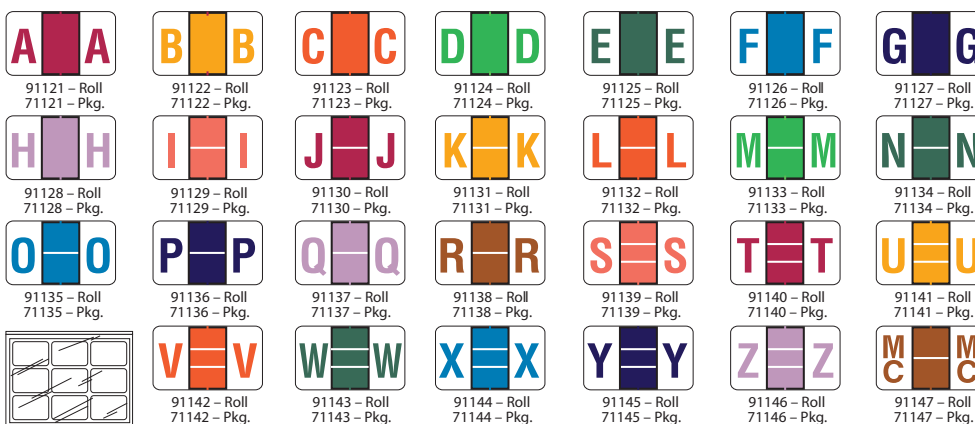

### 91100 / 71100 series Tab Products® & Jeter® 6100 compatible series

15/16"H x 1-1/2"W – Label size  
Laminated finish

**ROLL** / 500 labels per roll

**Roll Unit** – 31100 (10 rolls)

**PACK** / 252 labels per pkg.

9 labels per sheet





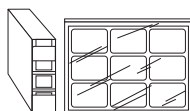
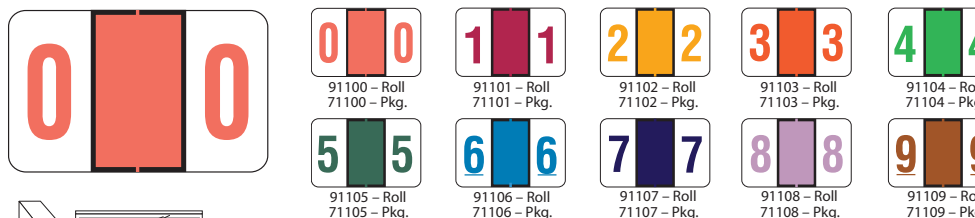













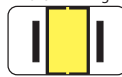









Sheet size: 5" x 3-1/2"

**Desktop Kit** – 71110 (2,016 labels)

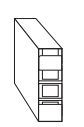
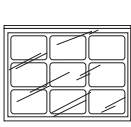

Dispenser Container only – 90110  
(Holds 10 Rolls)

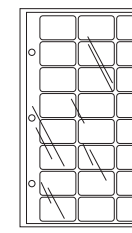
## compatible color code labels

 91521 - Roll 71521 - Pkg. 61521 - Ring	 91522 - Roll 71522 - Pkg. 61522 - Ring	 91523 - Roll 71523 - Pkg. 61523 - Ring	 91524 - Roll 71524 - Pkg. 61524 - Ring	 91525 - Roll 71525 - Pkg. 61525 - Ring	 91526 - Roll 71526 - Pkg. 61526 - Ring	 91527 - Roll 71527 - Pkg. 61527 - Ring	
 91528 - Roll 71528 - Pkg. 61528 - Ring	 91529 - Roll 71529 - Pkg. 61529 - Ring	 91530 - Roll 71530 - Pkg. 61530 - Ring	 91531 - Roll 71531 - Pkg. 61531 - Ring	 91532 - Roll 71532 - Pkg. 61532 - Ring	 91533 - Roll 71533 - Pkg. 61533 - Ring	 91534 - Roll 71534 - Pkg. 61534 - Ring	
 91535 - Roll 71535 - Pkg. 61535 - Ring	 91536 - Roll 71536 - Pkg. 61536 - Ring	 91537 - Roll 71537 - Pkg. 61537 - Ring	 91538 - Roll 71538 - Pkg. 61538 - Ring	 91539 - Roll 71539 - Pkg. 61539 - Ring	 91540 - Roll 71540 - Pkg. 61540 - Ring	 91541 - Roll 71541 - Pkg. 61541 - Ring	
 91542 - Roll 71542 - Pkg. 61542 - Ring	 91543 - Roll 71543 - Pkg. 61543 - Ring	 91544 - Roll 71544 - Pkg. 61544 - Ring	 91545 - Roll 71545 - Pkg. 61545 - Ring				
 91546 - Roll 71546 - Pkg. 61546 - Ring	 91547 - Roll 71547 - Pkg. 61547 - Ring						

91520 / 71520 / 61520 series  
Jeter® 5800, 7100, 7200  
compatible series

15/16"H x 1-5/8"W – Label size













**ROLL** / 500 labels per roll  
**Roll Unit** – 91520 (28 rolls)

Dispenser Container only – 90150  
(Holds 28 Rolls)

**PACK** / 252 labels per pkg.  
9 labels per sheet  
Sheet size: 5-1/4" x 3-1/4"

**Desktop Kit** – 71520 (2,016 labels)

**RINGBOOK** / 240 labels per pkg.  
24 labels per sheet / 3 drill holes  
Sheet size: 5-3/4" x 8-1/2"



























 91500 - Roll	 91501 - Roll	 91502 - Roll	 91503 - Roll				
 91504 - Roll	 91505 - Roll	 91506 - Roll	 91507 - Roll				
 91508 - Roll	 91509 - Roll						

91500 series  
Jeter® 7300 compatible series

15/16"H x 1-5/8"W – Label size

**ROLL** / 500 labels per roll

Dispenser Container only – 90110  
(Holds 10 Rolls)

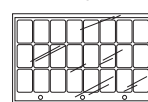









 62241 - Ring	 62242 - Ring	 62243 - Ring	 62244 - Ring	 62245 - Ring	 62246 - Ring	 62247 - Ring
 62248 - Ring	 62249 - Ring	 62250 - Ring	 62251 - Ring	 62252 - Ring	 62253 - Ring	 62254 - Ring
 62255 - Ring	 62256 - Ring	 62257 - Ring	 62258 - Ring	 62259 - Ring	 62260 - Ring	 62261 - Ring
 62262 - Ring	 62263 - Ring	 62264 - Ring	 62265 - Ring	 62266 - Ring	 62267 - Ring	

62240 series  
POS® 2000 compatible series

15/16"H x 1-5/8"W – Label size

**RINGBOOK** / 240 labels per pkg.  
24 labels per sheet / 3 drill holes  
Sheet size: 5-3/4" x 8-1/2"



 62231-AB - Ring	 62232-C - Ring	 62233-DEF - Ring	 62234-GHI - Ring	 62235-J - Ring	
 62236-KL - Ring	 62237-MNO - Ring	 62238-PQR - Ring	 62239-ST - Ring	 62240-UZ - Ring	

62230 multi-letter series  
POS® 3700 compatible series

1-1/2"H x 1-1/2"W – Label size

**RINGBOOK** / 150 labels per pkg.  
15 labels per sheet / 3 drill holes  
Sheet size: 5-1/2" x 8-1/2"

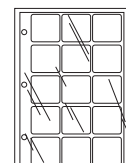

## compatible color code labels

### 91920 series Smead® NCC compatible series

1-5/32"H x 3-5/8"W – Label size  
**PACK** / 100 labels per pkg.  
 5 labels per sheet  
 Sheet size: 3-3/4" x 5-7/8"  
**Desktop Kit** – 31920 (1,500 labels)

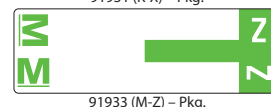
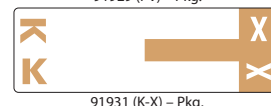
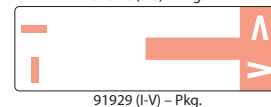
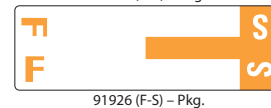
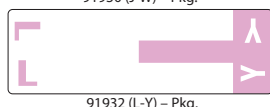
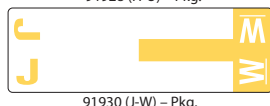
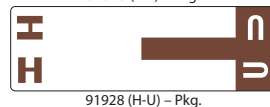
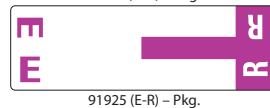
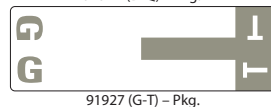
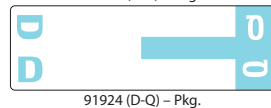
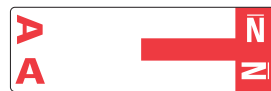
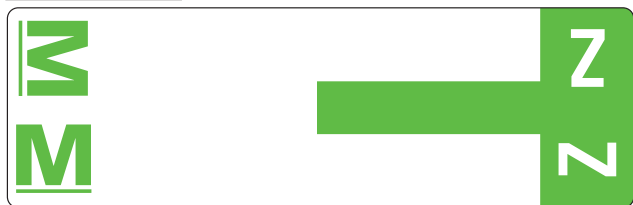
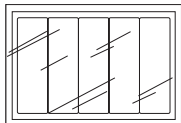

### 91820 / 71820 series Smead® ACC & ACCS compatible series

1-5/8"H x 1"W – Label size  
**ROLL** / 250 labels per roll  
**Roll Unit** – 41820 (26 rolls)  
 Dispenser Container only – 90150  
 (Holds 26 Rolls)  
**PACK** / 108 labels per pkg.  
 9 labels per sheet  
 Sheet size: 5-1/4" x 3-3/8"

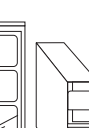
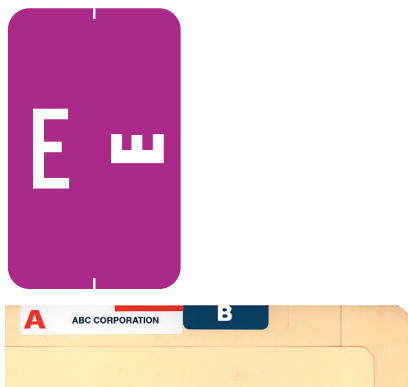

### 91800 series Smead® LCC compatible series

2"H x 1"W – Label size  
**ROLL** / 250 labels per roll  
**Roll Unit** – 41800 (10 rolls)  
 Dispenser Container only – 90110  
 (Holds 10 Rolls)





## compatible color code labels

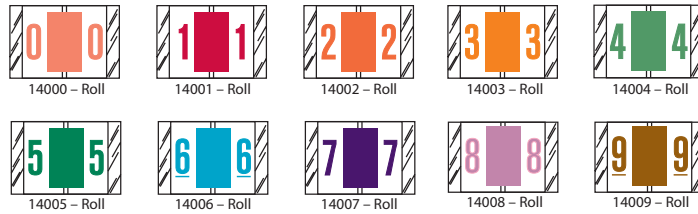
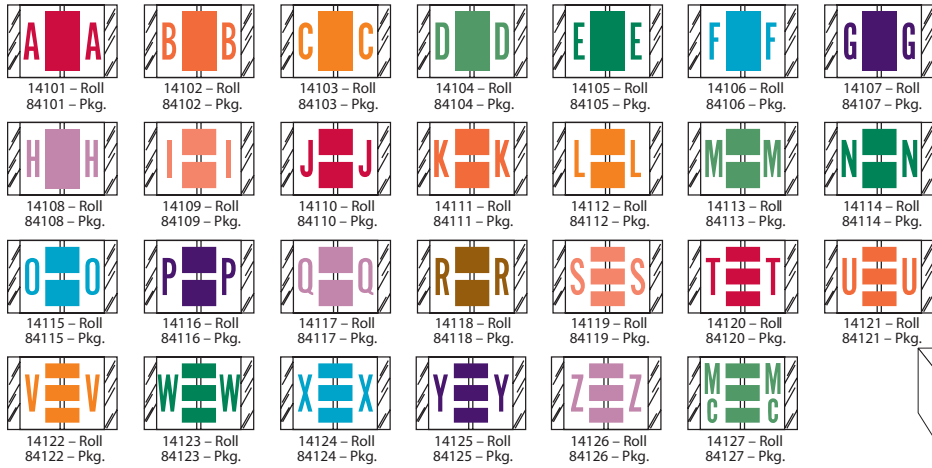

Dispenser Container only - 11015  
(Holds 10 Rolls)

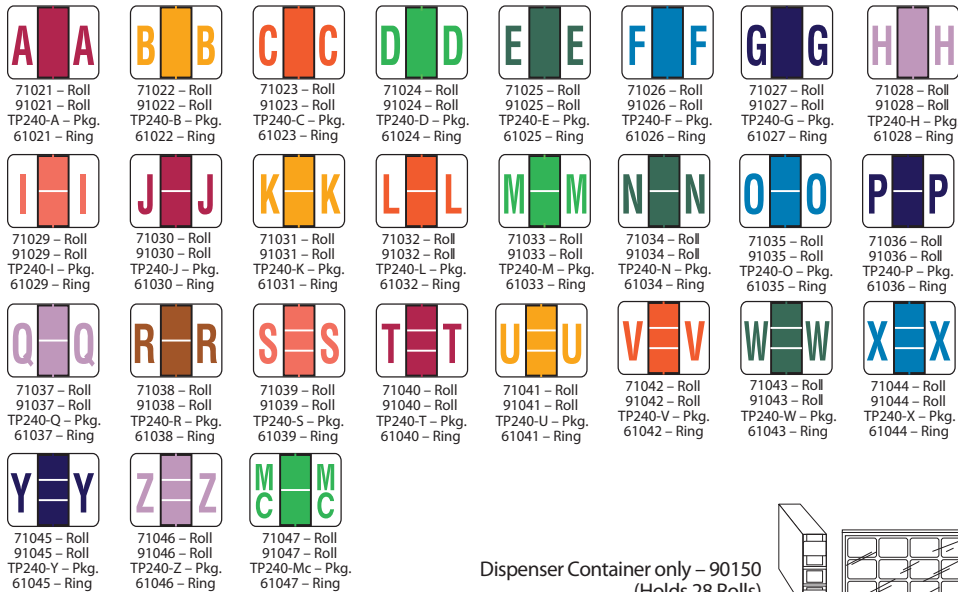

Dispenser Container only - 90150  
(Holds 28 Rolls)

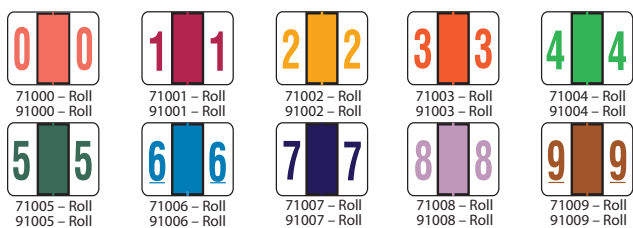

### 14100 / 84100 series Tab Products® compatible series

1"H x 1-1/2"W - Label size  
Original Col'RTab® construction  
**ROLL** / 500 labels per roll  
Dispenser Container only - 12000  
(Holds 30 Rolls)  
**PACK** / 100 labels per pkg.  
10 labels per strip  
Sheet size: 10" x 1-1/2"

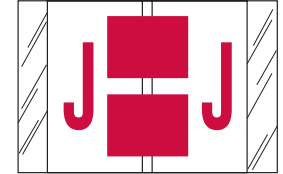

### 14000 series Tab Products® compatible series

1"H x 1-1/2"W - Label size  
Original Col'RTab® construction  
**ROLL** / 500 labels per roll



### 71020 series (Kimdura) rolls 91020 series (Paper laminated) rolls TP240 series (Paper laminated) pack Tab Products® 1283, 1286 & Smead® BCCS & BCCR compatible series 61020 series (Kimdura) ringbook sheets

1"H x 1-1/4"W - Label size  
**ROLL** / 71020 Series - 500 labels per roll  
**Roll Unit** - 71020 - Kimdura (28 rolls)  
**ROLL** / 91020 Series - 500 labels per roll  
**Roll Unit** - 41020 - Laminated (28 rolls)  
**PACK** / 240 labels per pkg.  
12 labels per sheet  
Sheet size: 5-1/2" x 3-3/8"  
**RINGBOOK** / 250 labels per pkg.  
50 labels per sheet / 3 drill holes  
Sheet size: 7-1/4" x 11-1/4"

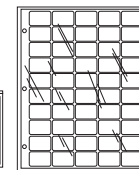

### 71000 series (Kimdura) 91000 series (Paper laminated) Tab Products® 1282 & Smead® BCCRN compatible series

1"H x 1-1/4"W - Label size  
**ROLL** / 71000 Series - 500 labels per roll  
**Roll Unit** - 71010 - Kimdura (10 rolls)  
**ROLL** / 91000 Series - 500 labels per roll  
**Roll Unit** - 91010 - Laminated (10 rolls)  
Dispenser Container only - 90110  
(Holds 10 Rolls)

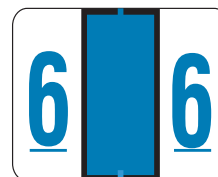

## compatible color code labels

### 71220 series Tab Products® compatible series

1/2"H x 1"W – Label size  
(Laminated)  
**ROLL** / 500 labels per roll  
Dispenser Container only – 90150  
(Holds 28 Rolls)

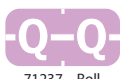
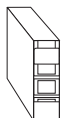

### 71200 series Tab Products® compatible series

1/2"H x 1"W – Label size  
(Laminated)  
**ROLL** / 500 labels per roll  
Dispenser Container only – 90110  
(Holds 10 Rolls)



### 90120 series Original Tabbies®

15/16"H x 1-1/2"W – Label size  
**ROLL** / 500 labels per roll



### 90100 series Original Tabbies®

15/16"H x 1-1/2"W – Label size  
**ROLL** / 500 labels per roll



Dispenser Container only – 90110  
(Holds 10 Rolls)

### 70230 series Original Tabbies®

1/2"H x 1"W – Label size  
**PACK** / 100 labels per pkg.  
25 labels per sheet  
Sheet size: 5-5/8" x 3-1/8"

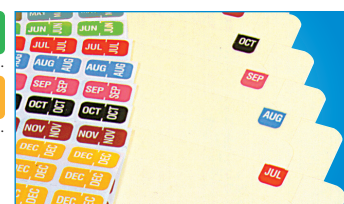
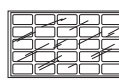

## original col'r'tab® color code labels

### 14560 Digi-Kolor™ series Original Col'R'Tab®

1"H x 1-1/2"W – Label size

**ROLL** / 500 labels per roll  
Original Col'R'Tab® construction

Dispenser Container only – 11015  
(Holds 10 Rolls)



14560 – Roll



14561 – Roll



14562 – Roll



14563 – Roll



14564 – Roll

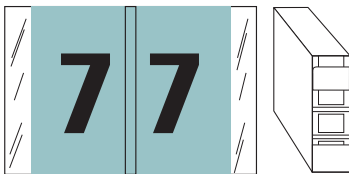

14565 – Roll



14566 – Roll



14567 – Roll



14568 – Roll



14569 – Roll

## compatible color code labels



94900 – Roll



94901 – Roll



94902 – Roll



94903 – Roll



94904 – Roll



94905 – Roll



94906 – Roll



94907 – Roll



94908 – Roll



94909 – Roll

### 94900 series Ames® compatible series

1-7/8"H x 1-7/8"W – Label size

**ROLL** / 500 labels per roll



12800 – Roll



12801 – Roll



12802 – Roll



12803 – Roll



12804 – Roll



12805 – Roll



12806 – Roll



12807 – Roll



12808 – Roll



12809 – Roll

### 12800 series SFI® compatible series

1-2/3"H x 1-1/2"W – Label size  
Original Col'R'Tab® construction

**ROLL** / 500 labels per roll

Dispenser Container only – 11015  
(Holds 10 Rolls)

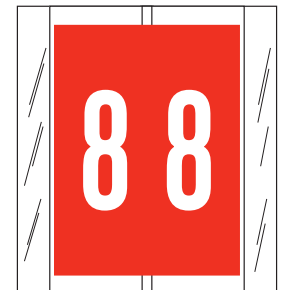



## compatible color code labels

### 11600 series Original Col'R Tab®

1-1/2"H x 1-1/2"W – Label size

**ROLL** / 500 labels per roll

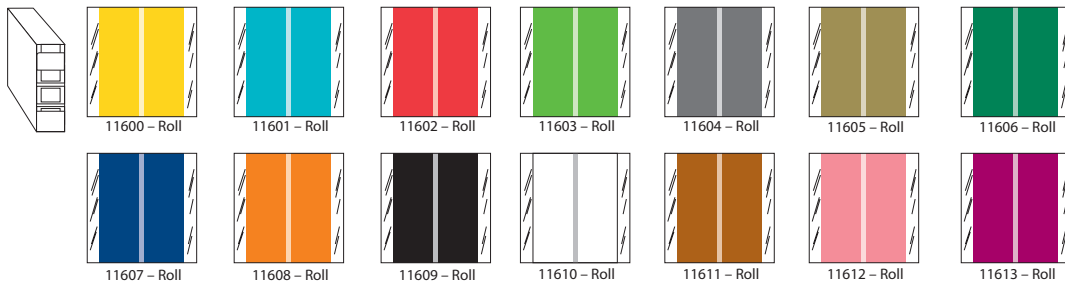

### 11100 series Original Col'R Tab®

1"H x 1-1/2"W – Label size

**ROLL** / 500 labels per roll

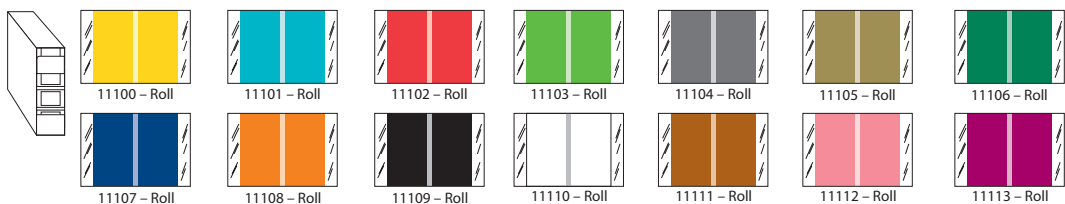

### 53300 series Kardex® compatible series

3/8"H x 1-7/16"W – Label size  
Original Col'R Tab® construction

**ROLL** / 1,000 labels per roll

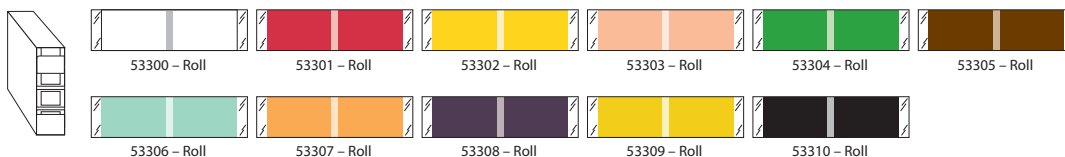

### 53500 series Kardex® compatible series

1/2"H x 1-7/16"W – Label size  
Original Col'R Tab® construction

**ROLL** / 1,000 labels per roll

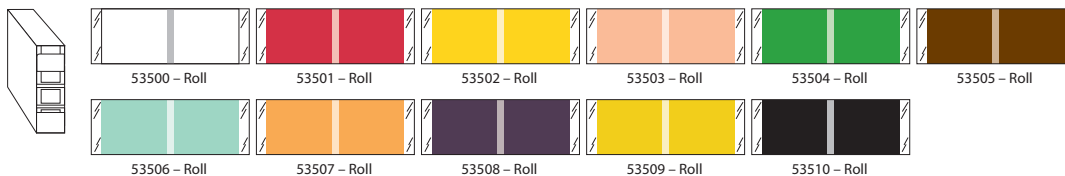

### 53110 series Kardex® compatible series

5/16"H x 1-7/16"W – Label size  
Original Col'R Tab® construction

**ROLL** / 2,000 labels per roll



### 70520 series Original Tabbies®

1"H x 1-1/2"W – Label size

**PACK** / 252 labels per pkg.  
9 labels per sheet  
Sheet size: 5" x 3-1/4"



### 91980 series Jeter® 9500 compatible series

3/4"H x 1-1/2"W – Label size

**ROLL** / 500 labels per roll

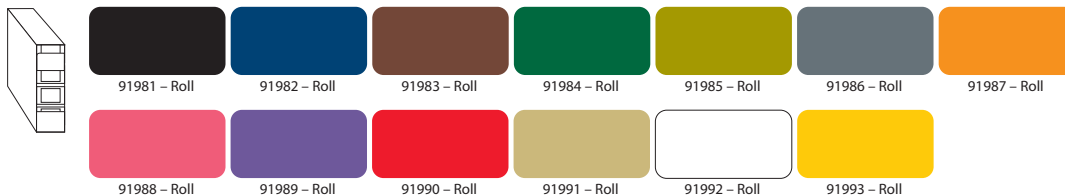

## yearcode labels

### 11700 / 51700 / 81700 series Original Col'R'Tab®

3/4"H x 1-1/2"W – Label size  
1,000 labels per roll • 500 labels per roll • 250 labels per pkg.

stock no. 1,000/roll	stock no. 500/roll	stock no. 250/pkg	item	color
11719	51719	81719	19	Black
11720	51720	81720	20	Yellow
11721	51721	81721	21	Lt. Blue
11722	51722	81722	22	Red
11723	51723	81723	23	Lt. Green
11724	51724	81724	24	Gray
11725	51725	81725	25	Gold



11723 - Roll • 51723 - Roll • 81723 - Pkg.



11724 - Roll • 51724 - Roll • 81724 - Pkg.



11725 - Roll • 51725 - Roll • 81725 - Pkg.

### 71700 series Original Col'R'Tab®

1-1/2"H x 3/4"W (Top Tab) – Label size  
1,000 labels per roll

stock no.	item	color
71719	19	Black
71720	20	Yellow
71721	21	Lt. Blue
71722	22	Red
71723	23	Lt. Green
71724	24	Gray
71725	25	Gold



71723 - Roll



71724 - Roll



71725 - Roll

### 70200 series Original Tabbies®

3/4"H x 1-1/2"W – Label size  
500 labels per roll

stock no.	item	color
70219	19	Pink
70220	20	Black
70221	21	Orange
70222	22	Blue
70223	23	Dk. Green
70224	24	Gold
70225	25	Gray



70223 - Roll



70224 - Roll



70225 - Roll

### 70500 series Original Tabbies®

1"H x 1/2"W (Top Tab) – Label size  
250 labels per pkg.

stock no.	item	color
70519	19	Pink
70520	20	Black
72521	21	Orange
72522	22	Blue
72523	23	Dk. Green
72524	24	Gold
72525	25	Gray



72523 - Pkg.



72524 - Pkg.



72525 - Pkg.

### 12600 series Acme Visible® compatible series

3/4"H x 1-1/2"W – Label size  
1,000 labels per roll  
Original Col'R'Tab® construction

stock no.	item	color
12619	19	Orange
12620	20	Green
12621	21	Pink
12622	22	Black
12623	23	Yellow
12624	24	Purple
12625	25	Red



12623 - Roll



12624 - Roll



12625 - Roll

### 14900 series Ames® compatible series

1-7/8"H x 1-7/8"W – Label size  
500 labels per roll

stock no.	item	color
14919	19	Green
14920	20	Red
14921	21	Gray
14922	22	Blue
14923	23	Orange
14924	24	Purple
14925	25	Black



14923 - Roll



14924 - Roll



14925 - Roll

# yearcode labels

## 12900 series SFI® compatible series

3/4"H x 1-1/2"W – Label size  
1,000 labels per roll  
Original Col'RTab® construction

stock no.	item	color
12919	19	Green
12920	20	Orange
12921	21	Blue
12922	22	Brown
12923	23	Gray
12924	24	Red
12925	25	Purple



12923 - Roll



12924 - Roll



12925 - Roll



14423 - Roll



14424 - Roll



14425 - Roll

## 14400 series Colwell® compatible series

3/4"H x 1-1/2"W – Label size  
500 labels per roll

stock no.	item	color
14419	19	Lt. Orange
14420	20	Yellow
14421	21	Red
14422	22	Dk. Green
14423	23	Brown
14424	24	Blue
14425	25	Pink

## 90600 series Barkley® compatible series

3/4"H x 1-1/2"W – Label size  
500 labels per roll

stock no.	item	color
90619	19	Gold
90620	20	Red
90621	21	Pink
90622	22	Yellow
90623	23	Orange
90624	24	Lt. Green
90625	25	Blue



90623 - Roll



90624 - Roll



90625 - Roll



94623 - Roll



94624 - Roll



94625 - Roll

## 94600 series GBS®/VRE® compatible series

3/4"H x 1-1/2"W – Label size  
500 labels per roll

stock no.	item	color
94619	19	Black
94620	20	Yellow
94621	21	Blue
94622	22	Pink
94623	23	Purple
94624	24	Orange
94625	25	Brown

## 90500 series Jeter® compatible series

3/4"H x 1-1/2"W – Label size  
500 labels per roll

stock no.	item	color
90519	19	Gray
90520	20	Blue
90521	21	Yellow
90522	22	Red
90523	23	Purple
90524	24	Gold
90525	25	Black



90523 - Roll



90524 - Roll



90525 - Roll



90423 - Roll



90424 - Roll

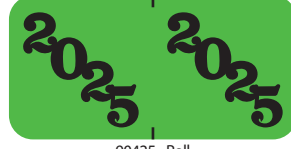

90425 - Roll

## 90400 series Jeter® compatible series

3/4"H x 1-1/2"W – Label size  
500 labels per roll

stock no.	item	color
90419	19	Orange
90420	20	Yellow
90421	21	Black
90422	22	Pink
90423	23	Blue
90424	24	Red
90425	25	Green



## yearcode labels

### 21800 / 90800 series Smead® compatible series

1/2"H x 1"W – Label size  
500 labels per roll • 250 labels per pkg.

stock no. 500/roll	stock no. 250/pkg	item	color
90819	21819	19	Black
90820	21820	20	Yellow
90821	21821	21	Lt. Blue
90822	21822	22	Pink
90823	21823	23	Purple
90824	21824	24	Orange
90825	21825	25	Brown



21823 - Pkg • 90823 - Roll



21824 - Pkg • 90824 - Roll

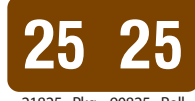

21825 - Pkg • 90825 - Roll

### 70800 series Smead® compatible series

1"H x 1/2"W (Top Tab) – Label size  
500 labels per roll

stock no.	item	color
70819	19	Black
70820	20	Yellow
70821	21	Lt. Blue
70822	22	Pink
70823	23	Purple
70824	24	Orange
70825	25	Brown



70823 - Roll



70824 - Roll



70825 - Roll



92023 - Roll



92024 - Roll



92025 - Roll

### 92000 series Tab Products® compatible series

3/4"H x 1-1/2"W – Label size  
500 labels per roll • Laminated

stock no.	item	color
92019	19	Brown
92020	20	Pink
92021	21	Red
92022	22	Lt. Orange
92023	23	Dk. Orange
92024	24	Lt. Green
92025	25	Dk. Green

### 91200 series Tab Products® compatible series

1/2"H x 1-1/8"W – Label size  
500 labels per roll • Kimdura

stock no.	item	color
91219	19	Brown
91220	20	Pink
91221	21	Red
91222	22	Lt. Orange
91223	23	Dk. Orange
91224	24	Lt. Green
91225	25	Dk. Green



91223 - Roll



91224 - Roll



91225 - Roll

### 90900 series Smead® compatible series

3/4"H x 1-1/2"W – Label size  
500 labels per roll



90923 - Roll



90924 - Roll



90925 - Roll

stock no.	item	color
90919	19	Gray
90920	20	Blue
90921	21	Yellow
90922	22	Red
90923	23	Purple
90924	24	Gold
90925	25	Black

### 97100 series PMA compatible series

3/4"H x 1-1/2"W – Label size  
500 labels per roll



97123 - Roll

97124 - Roll

97125 - Roll



stock no.	item	stock no.	item	stock no.	item	stock no.	item	stock no.	item	stock no.	item	stock no.	item	color
97119	19	97120	20	97121	21	97122	22	97123	23	97124	24	97125	25	Aqua-Holographic
97219	19	97220	20	97221	21	97222	22	97223	23	97224	24	97225	25	Blue-Holographic
97319	19	97320	20	97321	21	97322	22	97323	23	97324	24	97325	25	Green-Holographic
97419	19	97420	20	97421	21	97422	22	97423	23	97424	24	97425	25	Orange-Holographic
97519	19	97520	20	97521	21	97522	22	97523	23	97524	24	97525	25	Red-Holographic
97619	19	97620	20	97621	21	97622	22	97623	23	97624	24	97625	25	Violet-Holographic

**tabbies®**



[www.tabbies.com](http://www.tabbies.com)

[www.tabbiescustomlabels.com](http://www.tabbiescustomlabels.com)



*Family owned & operated  
since 1955*

Manufacturer #084371

## **OTHER CATALOGS AVAILABLE:**

- Custom Label and Print Guide**
- Filing, Indexing & Labeling Products**
- Legal Filing, Indexing & Labeling Products**
  - Religious Products**
- Shipping & Handling Products**
- Veterinary Filing Products**